

TouchXpress™ Family

CPT212B Data Sheet

The CPT212B device, part of the TouchXpress family, is designed to quickly add capacitive touch via an I2C interface by eliminating the firmware complexity and reducing the development time for capacitive sensing applications.

Supporting up to 12 capacitive sensor inputs in packages as small as a 3 mm x 3 mm QFN, the CPT212B is a highly-integrated device that interfaces via I2C to the host processor to provide a simple solution for adding capacitive touch. The device also comes with advanced features like moisture immunity, wake-on proximity, and buzzer feedback for an enhanced user experience. No firmware development is needed, and all the capacitive touch sense parameters can be configured using a simple GUI-based configurator. By eliminating the need for complex firmware development, the CPT212B device enables rapid user interface designs with minimal development effort.

The CPT212B device is ideal for a wide range of capacitive touch applications including the following:

- Home appliances
- Instrument / Control panels
- White goods
- Medical equipment
- Consumer electronics
- Lighting control

KEY FEATURES

- No firmware development required
- Simple GUI-based configurator
- 12 Capacitive Sensor inputs with programmable sensitivity
- I2C interface to communicate to and configure from the host
- Lowest power capacitive sense solution
 - Active — 200 μ A
 - Sleep — 1 μ A
- Wake on proximity
- Superior noise immunity: SNR up to 270:1
- Moisture immunity
- Mutually-exclusive touch qualifier
- Buzzer output for audible touch feedback

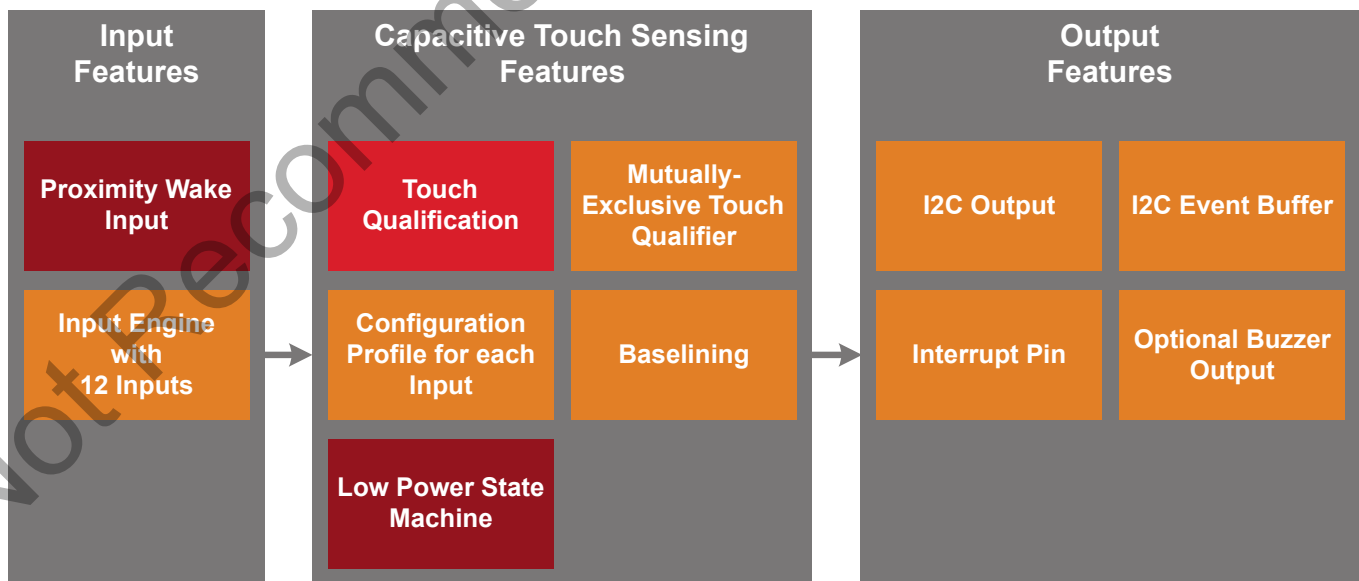

Lowest power mode with feature operational:

- Active
- Optimized Active
- Low Power Sleep

1. Feature List and Ordering Information

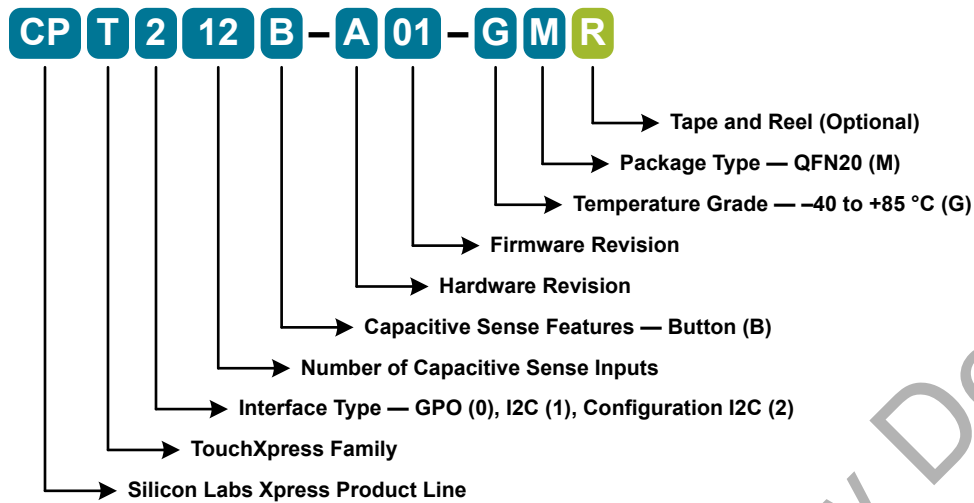

Figure 1.1. CPT212B Part Numbering

The CPT212B has the following features:

- Capacitive sensing input engine with 12 inputs
- Post-sample touch qualification engine
- Configuration profile space in non-volatile memory
- I2C event buffer with interrupt pin to signal when new touch events have been qualified
- Configuration loading with both the dedicated configuration interface and through the I2C interface
- Low power state machine to minimize current draw in all use cases
- Capacitive proximity sensing input
- Buzzer output
- Mutually-exclusive touch qualifier

Table 1.1. Product Selection Guide

Ordering Part Number	Configuration over I2C	Pb-free (RoHS Compliant)	Temperature Range	Package
CPT212B-A01-GM	Yes	Yes	-40 to +85 °C	QFN20

See <http://www.silabs.com/products/interface/capacitive-touch-controllers> for other devices available in the TouchXpress family.

Table of Contents

1. Feature List and Ordering Information	2
2. Typical Connection Diagrams	5
2.1 Signal, Analog, and Power Connections	5
2.2 Configuration	6
3. Electrical Specifications	7
3.1 Electrical Characteristics	7
3.1.1 Recommended Operating Conditions	7
3.1.2 Power Consumption	8
3.1.3 Reset and Supply Monitor	9
3.1.4 Configuration Memory	9
3.1.5 I2C Configuration Interface	10
3.1.6 Capacitive Sense	11
3.1.7 Buzzer Output	12
3.2 Thermal Conditions	12
3.3 Absolute Maximum Ratings	13
3.4 Typical Performance Curves	14
4. Functional Description	17
4.1 Capacitive Sensing Input	17
4.1.1 Introduction	17
4.1.2 Touch Qualification Criteria	17
4.1.3 Thresholds	17
4.1.4 Debounce Counter	18
4.1.5 Touch Deltas	18
4.1.6 Auto-Accumulation and Averaging	18
4.1.7 Drive Strength	18
4.1.8 Active Mode Scan Enable	18
4.1.9 Active Mode Scan Period	18
4.1.10 Active Mode Scan Type	19
4.1.11 Sleep Mode Scan Period	19
4.1.12 Active Mode and Sleep Mode Transitions	20
4.2 I2C Event Buffer Interface	20
4.2.1 Introduction	20
4.2.2 Startup Behavior	21
4.2.3 Sensing Mode Event Packet Structure	21
4.2.4 Packet Retrieval in Sensing Mode	22
4.2.5 Defined Event Types	23
4.2.6 Description Bytes for Touch Events	23
4.2.7 Slave Address	24
4.2.8 Entering Sensing Mode from Configuration Loading Mode	24
4.2.9 Determining Configuration Validity	24
4.2.10 Configuration Loading Procedure	26
4.2.11 CRC Algorithm	28

4.3	Capacitive Proximity Sensing	.29
4.3.1	Wake on Proximity	.29
4.3.2	Proximity Configuration	.29
4.4	Buzzer Output	.29
4.4.1	Introduction	.29
4.4.2	Buzzer Configuration	.30
4.5	Mutually Exclusive Buttons	.30
4.6	Configuration Profile	.31
5.	Pin Definitions	32
5.1	CPT212B QFN20 Pin Definitions	.32
6.	QFN20 Package Specifications	34
6.1	QFN20 Package Dimensions	.34
6.2	QFN20 PCB Land Pattern	.36
6.3	QFN20 Package Marking	.37
7.	Relevant Application Notes	38
8.	Revision History	39
8.1	Revision 1.1	.39
8.2	Revision 1.0	.39

Not Recommended for New Designs

2. Typical Connection Diagrams

2.1 Signal, Analog, and Power Connections

Figure 2.1 Connection Diagram on page 5 shows a typical connection diagram for the power pins of CPT212B devices.

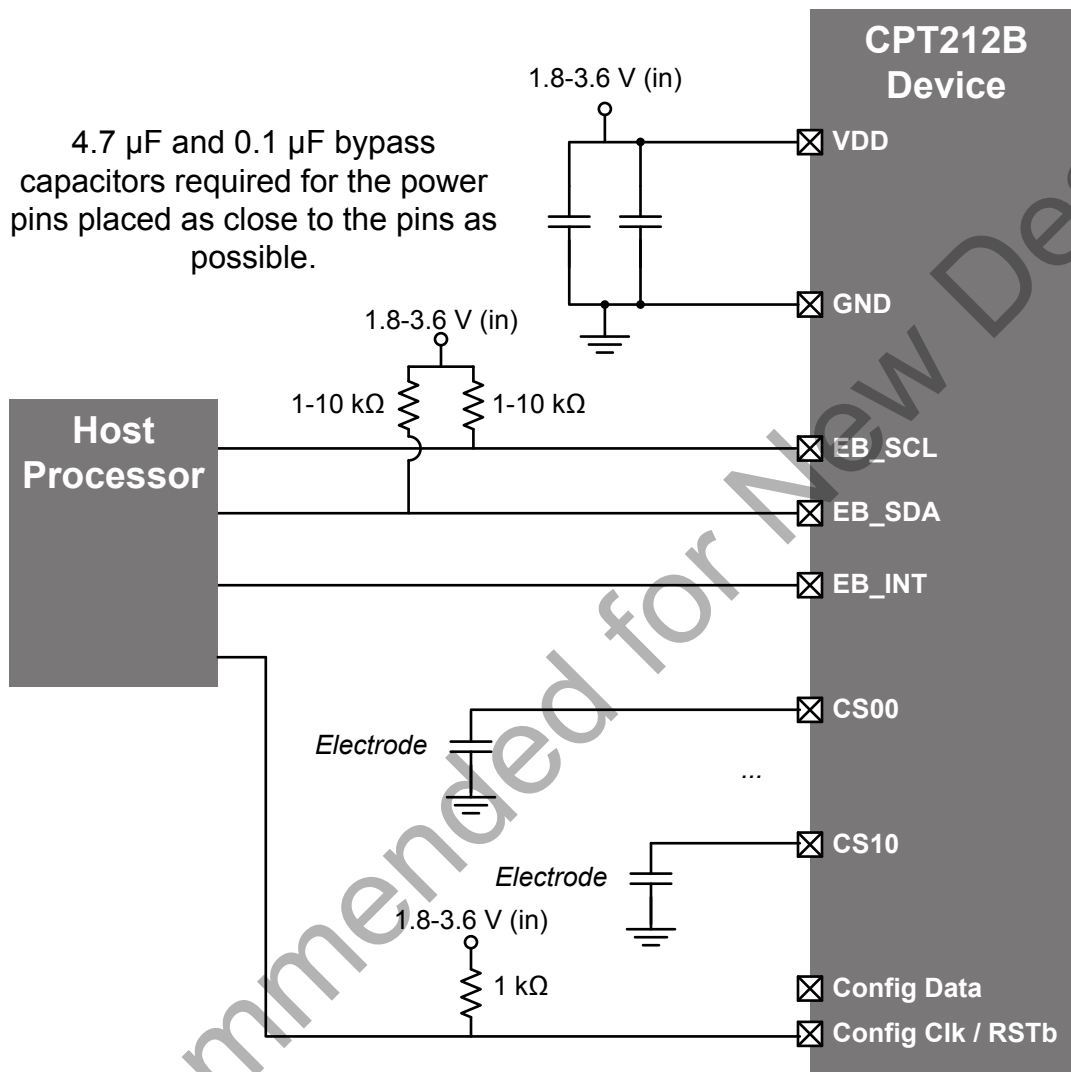

Figure 2.1. Connection Diagram

Note: The I2C pull-up resistor values will vary depending on the speed requirements of the bus and the host processor requirements.

2.2 Configuration

There are two ways to configure the CPT212B: through the I2C interface, and through the dedicated configuration interface. The diagram below shows a typical connection diagram for the dedicated configuration interface pins. The ToolStick Base Adapter is available on the evaluation board.

Note: The USB Debug Adapter does not support configuration for TouchXpress devices. Instead, the ToolStick Base Adapter must be used to configure these devices.

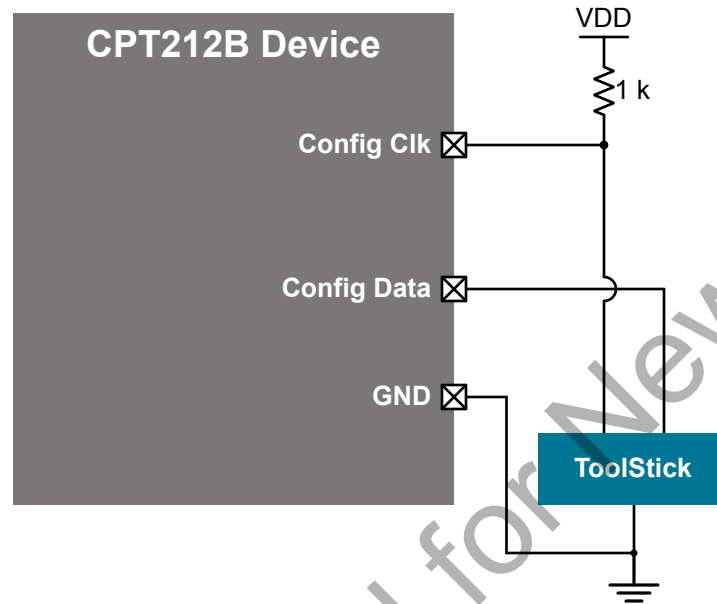

Figure 2.2. Configuration Connection Diagram

3. Electrical Specifications

3.1 Electrical Characteristics

All electrical parameters in all tables are specified under the conditions listed in [3.1.1 Recommended Operating Conditions](#), unless stated otherwise.

3.1.1 Recommended Operating Conditions

Table 3.1. Recommended Operating Conditions

Parameter	Symbol	Test Condition	Min	Typ	Max	Unit
Operating Supply Voltage on VDD	V _{DD}		1.8	2.4	3.6	V
Minimum RAM Data Retention Voltage on VDD ¹	V _{RAM}	Not in Sleep Mode	—	1.4	—	V
		Sleep Mode	—	0.3	0.5	V
Operating Ambient Temperature	T _A		−40	—	85	°C

Note:

1. All voltages with respect to GND.

3.1.2 Power Consumption

See 3.4 Typical Performance Curves for power consumption plots.

Table 3.2. Power Consumption

Parameter	Symbol	Test Condition	Min	Typ	Max	Unit
Active Mode Supply Current	I _{DD}	Sensing Mode	—	3.1	—	mA
		Configuration Mode	—	3.1	—	mA
Optimized Active Mode Supply Current	I _{DD}		—	180	—	μA
Sleep Mode Current ^{1, 2}	I _{DD}	3 sensors or fewer	—	0.78	—	μA
		4 sensors	—	0.79	—	μA
		5 sensors	—	0.81	—	μA
		6 sensors	—	0.82	—	μA
		7 sensors	—	0.84	—	μA
		10 sensors	—	0.88	—	μA
		12 sensors	—	0.95	—	μA
System Current with Varying Scan Time — Base with One Sensor ¹	I _{DD}	Scan period = 10 ms	—	154	—	μA
		Scan period = 20 ms	—	77	—	μA
		Scan period = 50 ms	—	31	—	μA
		Scan period = 75 ms	—	21	—	μA
		Scan period = 100 ms	—	16	—	μA
System Current with Varying Scan Time — Each Additional Sensor ¹	I _{DD}	Scan period = 10 ms	—	47	—	μA
		Scan period = 20 ms	—	23	—	μA
		Scan period = 50 ms	—	9	—	μA
		Scan period = 75 ms	—	6	—	μA
		Scan period = 100 ms	—	5	—	μA

Note:

1. Measured with Free Run Mode disabled and sensors set to 4x accumulation, 8x gain.
2. Measured with scan period set to 250 ms.

3.1.3 Reset and Supply Monitor

Table 3.3. Reset and Supply Monitor

Parameter	Symbol	Test Condition	Min	Typ	Max	Unit
V _{DD} Supply Monitor Threshold	V _{VDDM}	Reset Trigger	1.7	1.75	1.8	V
	V _{WARN}	Early Warning	1.8	1.85	1.9	V
Power-On Reset (POR) Monitor Threshold	V _{POR}	Rising Voltage on V _{DD}	—	1.75	—	V
		Falling Voltage on V _{DD}	0.75	1.0	1.3	V
V _{DD} Ramp Time	t _{RMP}	Time to V _{DD} ≥ 1.8 V	—	—	3	ms
RST Low Time to Generate Reset	t _{RSTL}		15	—	—	μs
Boot Time ¹	t _{boot}	1 sensor	—	25	—	ms
		2 sensors	—	40	—	ms
		3 sensors	—	55	—	ms
		4 sensors	—	70	—	ms
		5 sensors	—	85	—	ms
		6 sensors	—	100	—	ms
		7 sensors	—	115	—	ms
		8 sensors	—	130	—	ms
		9 sensors	—	145	—	ms
		10 sensors	—	160	—	ms
		11 sensors	—	175	—	ms
		12 sensors	—	200	—	ms

Note:

1. Boot time is defined as the time from when the device enters sensing mode until the first capacitive sensing scan occurs.

3.1.4 Configuration Memory

Table 3.4. Configuration Memory

Parameter	Symbol	Test Condition	Min	Typ	Max	Units
Endurance (Write/Erase Cycles)	N _{WE}		20 k	100 k	—	Cycles

Note:

1. Data Retention Information is published in the Quarterly Quality and Reliability Report.

3.1.5 I2C Configuration Interface

Table 3.5. I2C Configuration Interface

Parameter	Symbol	Test Condition	Min	Typ	Max	Units
I2C Configuration Interface Boot Time	t_{I2C_boot}	Time after any reset until the I2C Configuration Interface is ready to receive commands	—	200	—	μ s
I2C Configuration Erase Delay	t_{erase}		—	45	—	ms
I2C Configuration Write Delay	t_{write}		—	1	—	ms
I2C Configuration CRC Delay	t_{CRC}		—	45	—	ms
I2C Configuration Validity Check Delay	t_{valid}		—	200	—	μ s
Interrupt Pin Low Time After Entering Sensing Mode	t_{INT_low}		—	—	5	μ s

Not Recommended for New Designs

3.1.6 Capacitive Sense

Table 3.6. Capacitive Sense

Parameter	Symbol	Test Condition	Min	Typ	Max	Unit
Scan Time Per Sensor ¹	t_{SCAN}	Accumulation = 1x	—	64	—	μs
		Accumulation = 4x	—	256	—	μs
		Accumulation = 8x	—	512	—	μs
		Accumulation = 16x	—	1.024	—	ms
		Accumulation = 32x	—	2.048	—	ms
		Accumulation = 64x	—	4.096	—	ms
Signal to Noise Ratio ^{1, 2}	SNR	Accumulation = 1x	—	90:1	—	codes
		Accumulation = 4x	—	180:1	—	codes
		Accumulation = 8x	—	182:1	—	codes
		Accumulation = 16x	—	210:1	—	codes
		Accumulation = 32x	—	230:1	—	codes
		Accumulation = 64x	—	270:1	—	codes
Conversion Time	t_{CONV}	Gain = 1x	—	205	—	μs
		Gain = 2x	—	123	—	μs
		Gain = 3x	—	98	—	μs
		Gain = 4x	—	85	—	μs
		Gain = 5x	—	76	—	μs
		Gain = 6x	—	72	—	μs
		Gain = 7x	—	67	—	μs
		Gain = 8x	—	64	—	μs
Total Processing Time ³	t_{PROC}	1 sensor	—	576	—	μs
		2 sensors	—	796	—	μs
		3 sensors	—	1.0	—	ms
		4 sensors	—	1.2	—	ms
		5 sensors	—	1.4	—	ms
		6 sensors	—	1.7	—	ms
		7 sensors	—	1.9	—	ms
		8 sensors	—	2.1	—	ms
		9 sensors	—	2.3	—	ms
		10 sensors	—	2.6	—	ms
		11 sensors	—	2.8	—	ms
		12 sensors	—	3.0	—	ms
Maximum External Capacitive Load	C_{EXTMAX}	Gain = 8x	—	45	—	pF
		Gain = 1x	—	500	—	pF

Parameter	Symbol	Test Condition	Min	Typ	Max	Unit
Maximum External Series Impedance	R_{EXTMAX}	Gain = 8x	—	50	—	k Ω

Note:

1. Measured with gain set to 8x.
2. Measured with an evaluation board with 1/16" overlay using Capacitive Sense Profiler.
3. Sensors configured to 8x gain, 1x accumulation with sensor sampling and system processing time included and mutually-exclusive buttons, buzzer, and touch time-outs disabled.

3.1.7 Buzzer Output

Table 3.7. Buzzer Output

Parameter	Symbol	Test Condition	Min	Typ	Max	Unit
Output High Voltage (High Drive)	V_{OH}	$I_{OH} = -3$ mA	$V_{DD} - 0.7$	—	—	V
Output Low Voltage (High Drive)	V_{OL}	$I_{OL} = 8.5$ mA	—	—	0.6	V
Output High Voltage (Low Drive)	V_{OH}	$I_{OH} = -1$ mA	$V_{DD} - 0.7$	—	—	V
Output Low Voltage (Low Drive)	V_{OL}	$I_{OL} = 1.4$ mA	—	—	0.6	V
Weak Pull-Up Current	I_{PU}	$V_{DD} = 1.8$ V $V_{IN} = 0$ V	—	-4	—	μ A
		$V_{DD} = 3.6$ V $V_{IN} = 0$ V	-35	-20	—	μ A

3.2 Thermal Conditions

Table 3.8. Thermal Conditions

Parameter	Symbol	Test Condition	Min	Typ	Max	Unit
Thermal Resistance*	θ_{JA}	QFN20 Packages	—	60	—	$^{\circ}$ C/W

Note:

1. Thermal resistance assumes a multi-layer PCB with any exposed pad soldered to a PCB pad.

3.3 Absolute Maximum Ratings

Stresses above those listed in [Table 3.9 Absolute Maximum Ratings on page 13](#) may cause permanent damage to the device. This is a stress rating only and functional operation of the devices at those or any other conditions above those indicated in the operation listings of this specification is not implied. Exposure to maximum rating conditions for extended periods may affect device reliability. For more information on the available quality and reliability data, see the Quality and Reliability Monitor Report at <http://www.silabs.com/support/quality/pages/default.aspx>.

Table 3.9. Absolute Maximum Ratings

Parameter	Symbol	Test Condition	Min	Max	Unit
Ambient Temperature Under Bias	T_{BIAS}		-55	125	°C
Storage Temperature	T_{STG}		-65	150	°C
Voltage on V_{DD}	V_{DD}		GND-0.3	4.0	V
Voltage on I/O pins or RSTb	V_{IN}		GND-0.3	$V_{DD} + 0.3$	V
Total Current Sunk into Supply Pin	I_{VDD}		—	400	mA
Total Current Sourced out of Ground Pin	I_{GND}		400	—	mA
Current Sourced or Sunk by Any I/O Pin or RSTb	I_{IO}		-100	100	mA
Maximum Total Current through all Port Pins	I_{IOTOT}		—	200	mA
Operating Junction Temperature	T_J		-40	105	°C
Exposure to maximum rating conditions for extended periods may affect device reliability.					

3.4 Typical Performance Curves

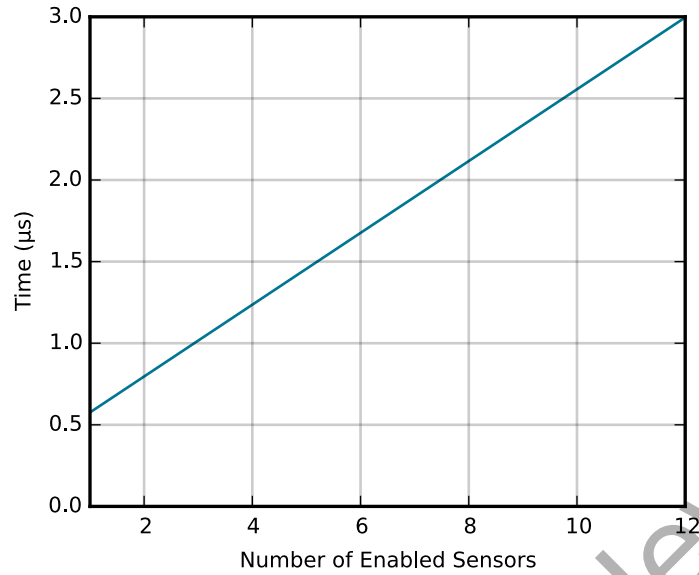

Figure 3.1. Active Mode Processing Time Per Sensor

Note: Active mode processing time per sensor measured with sensors configured to 1x accumulation, 8x gain. Sensor sampling and system processing time is included with mutually-exclusive buttons, the buzzer, and touch time-outs disabled.

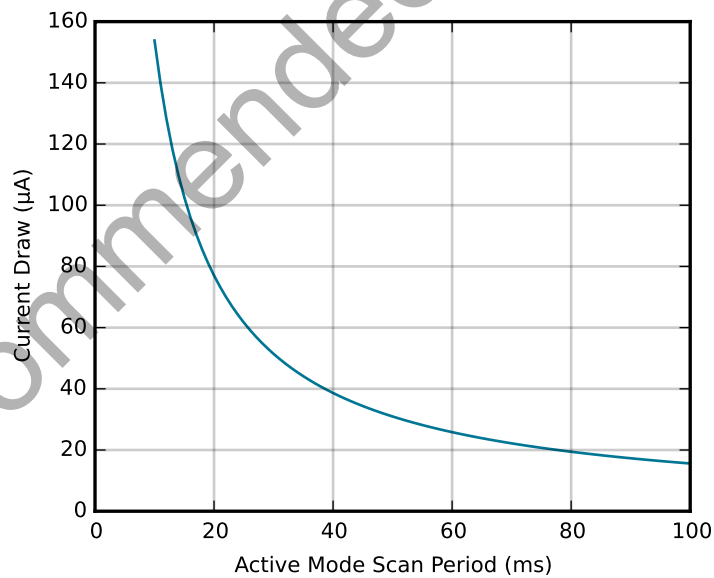

Figure 3.2. Current vs. Active Mode Scan Period — Base Current Consumption

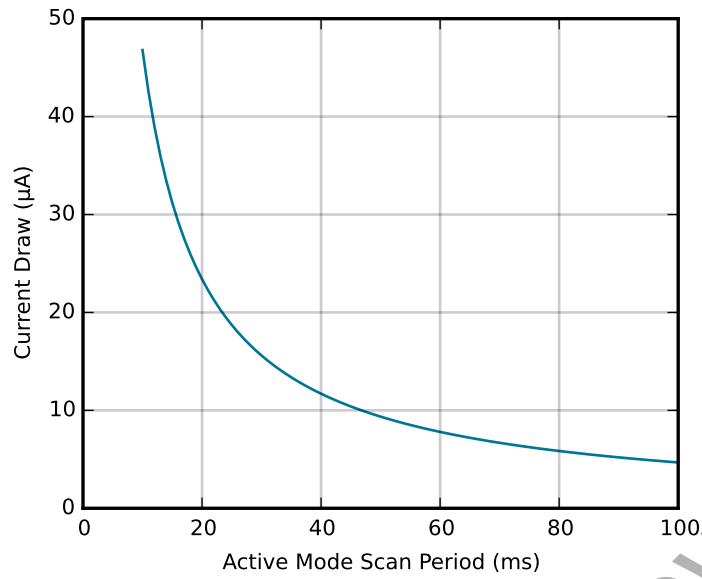

Figure 3.3. Current vs. Active Mode Scan Period — Current Consumption for Each Additional Sensor

Note: Active mode scan period current draw measured with free run mode disabled and all 12 sensors enabled at 4x accumulation, 8x gain. In addition, the buzzer, and mutually-exclusive button groups were disabled.

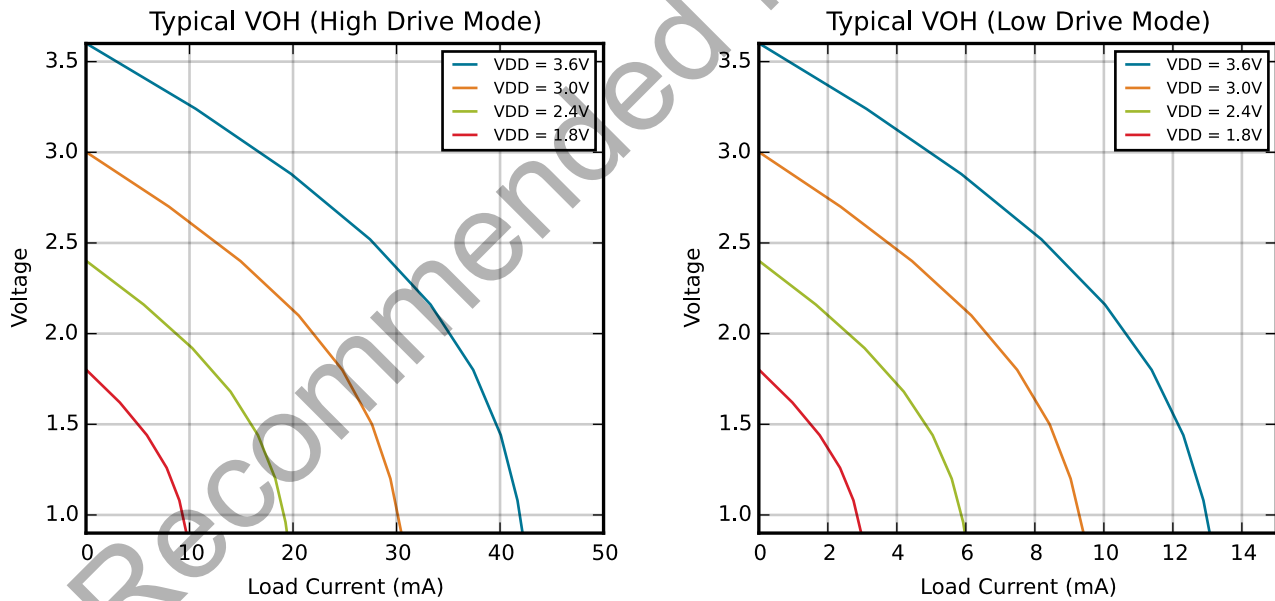

Figure 3.4. Typical V_{OH} Curves

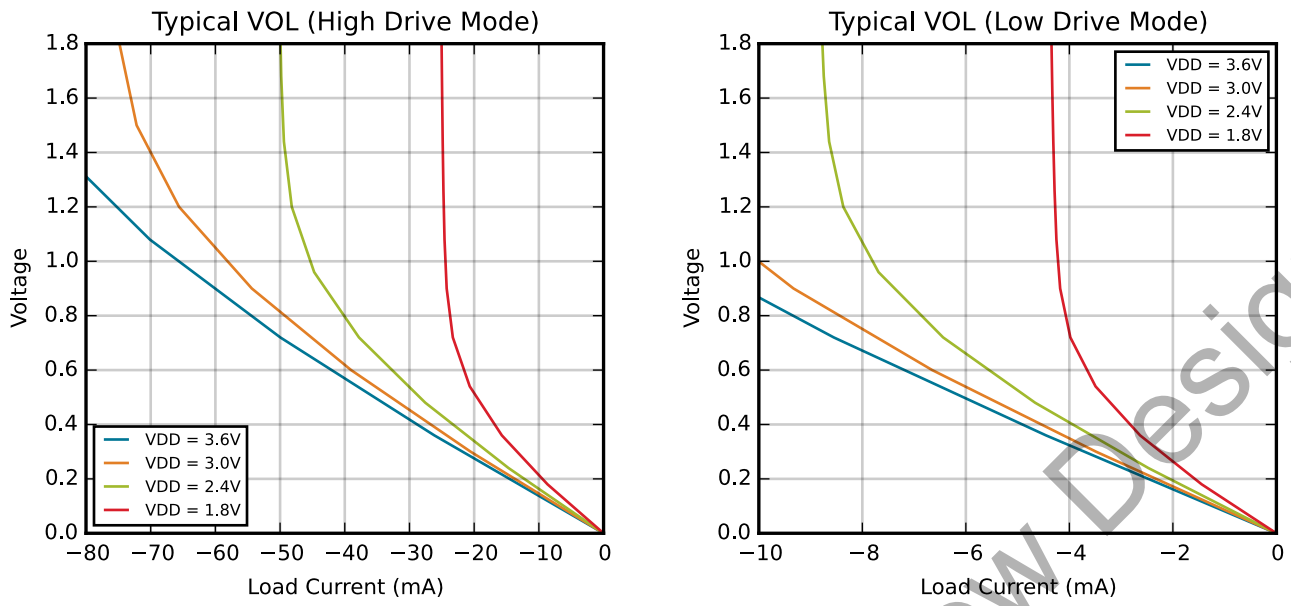

Figure 3.5. Typical V_{OL} Curves

4. Functional Description

4.1 Capacitive Sensing Input

4.1.1 Introduction

The capacitive to digital converter uses an iterative, charge-timing self-capacitance technique to measure capacitance on an input pin. Sampling is configured and controlled by settings in the non-volatile configuration profile, which can be changed through the 2-pin configuration interface.

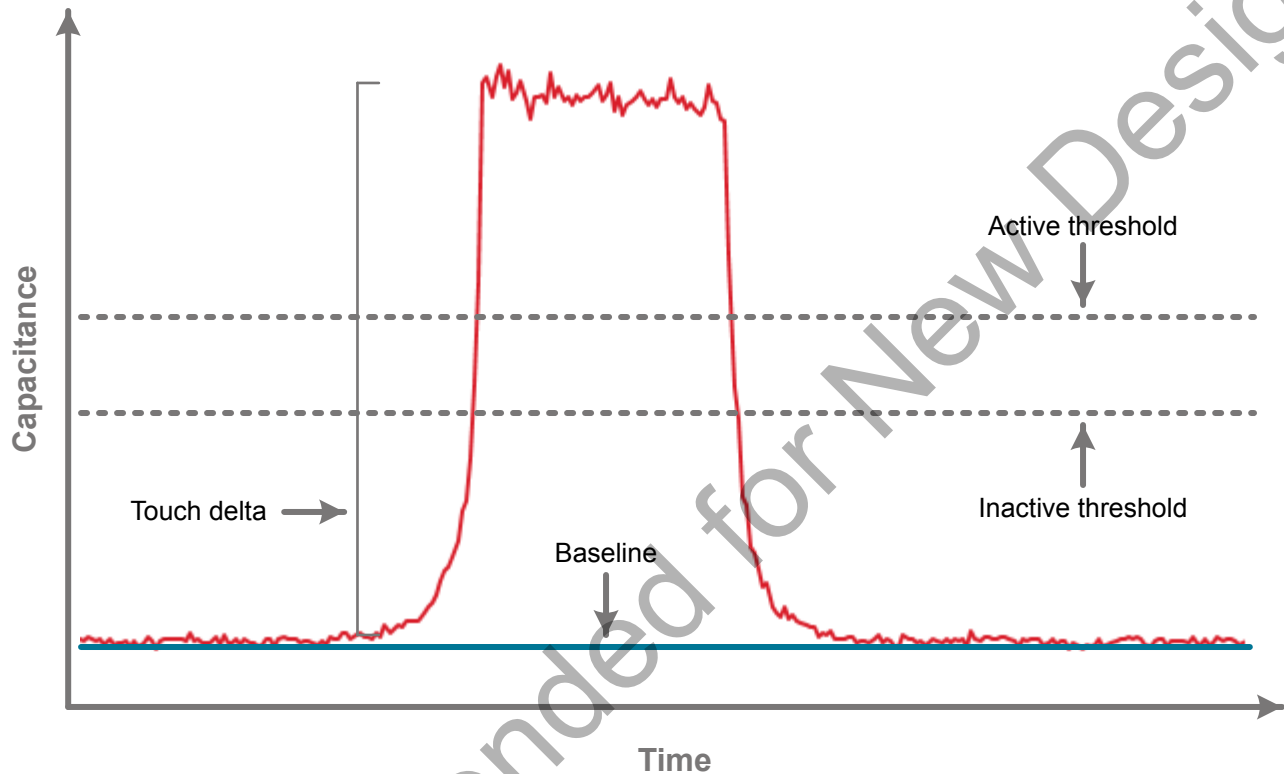

Figure 4.1. Capacitive Sense Data Types

4.1.2 Touch Qualification Criteria

The device detects a touch event when an inactive (untouched) input enabled by the input enable mask detects a sequence of measurements that cross the active threshold.

The device detects a touch release event when an active (touched) input enabled by the input enable mask detects a sequence of measurements that cross the inactive threshold.

The debounce configuration profile parameter defines how many measurements in a row must cross a threshold before a touch or release is qualified. In electrically noisy environments more heavily filtered data is used for qualification.

4.1.3 Thresholds

Capacitive sensing inputs use input-specific thresholds for touch qualification. Each input uses two thresholds, one to detect inactive-to-active transitions on the input, and another to determine active-to-inactive transitions on the input. The inputs use two thresholds to add hysteresis and prevent active/inactive ringing on inputs. Each threshold can be set through Simplicity Studio tools and all thresholds are stored in non-volatile memory in the device's configuration profile.

Thresholds are defined as percentages of a capacitive sensing input's touch delta.

4.1.4 Debounce Counter

Each capacitive sensing input maintains its own debounce counter. For an inactive sensor, this counter tracks the number of successive samples which have crossed that input's active threshold. For an active sensor, this counter tracks the number of successive samples which have crossed the inactive threshold. When the counter reaches a terminal value defined in the the configuration profile, the touch/release event is qualified.

4.1.5 Touch Deltas

Each capacitive sensing input uses a stored touch delta value that describes the expected difference between inactive and active capacitive sensing output codes. This value is stored in the configuration profile for the system and is used by the touch qualification engine, which defines inactive and active thresholds relative to the touch delta.

The touch deltas are stored in the configuration profile in a touch delta/16 format. For this reason, touch deltas must be configured as multiples of 16.

4.1.6 Auto-Accumulation and Averaging

Capacitive sensing inputs have an auto-accumulate and average post-sample filter that can be used to improve signal strength if needed. Settings stored in the configuration profile can configure the engine to accumulate 1, 4, 8, 16, 32, or 64 samples. After the defined number of samples have been accumulated, the result is divided by either 1, 4, 8, 16, 32, or 64, depending on the accumulation setting. This auto-accumulated and averaged value is the sample output used for all touch qualification processing. Note that sample time per sensor increases as the level of accumulation increases. To reduce current consumption, the engine should not be set to auto-accumulate unless it is required to achieve acceptable signal strength due to thick overlays or other system-level factors.

4.1.7 Drive Strength

The drive strength of the current source used to charge the electrode being measured by the capacitive sensing input can be adjusted in integer increments from 1x to 8x (8x is the default). High drive strength gives the best sensitivity and resolution for small capacitors, such as those typically implemented as touch-sensitive PCB features. To measure larger capacitance values, the drive strength should be lowered accordingly. The highest drive strength setting that yields capacitive sensing output which does not saturate the sensing engine when the electrode is active (touched) should always be used to maximize input sensitivity.

4.1.8 Active Mode Scan Enable

Active mode scanning of capacitive sensing inputs is controlled by an enable setting for each capacitive sensing input. This setting is stored in the configuration profile.

4.1.9 Active Mode Scan Period

The capacitive sensing input engine stays in active mode whenever one or more inputs have qualified as active. During this time, the sensors scan at a periodicity defined by the active mode scan period, which is stored in the configuration profile. Every active mode scan pushes new samples through the processing engine, which checks for new touch and release events on all enabled inputs.

If free run mode is enabled, the engine will repeatedly scan all enabled inputs during the active mode scan period. In this mode of operation, the active mode scan period is used as a timer to determine how much time has passed since the last qualified active sensor has been seen. When a defined amount of time without a qualified touch event has occurred, the engine switches to a low power mode using the sleep mode scan period, and conserves current.

If free run mode is disabled, the engine will enter a low power state after completing one scan of all enabled inputs and processing the resulting samples. The engine will remain in this low power state until it wakes, at a time defined by active mode scan period, to perform another scan.

4.1.10 Active Mode Scan Type

The active mode scan type, which is stored in the configuration profile, controls whether the capacitive sensing engine in active mode will scan only once during the active mode scan period before going to sleep, or whether the engine will continue scanning as quickly as possible during the active mode scan period, never entering a low power state.

For optimal responsiveness, the engine should be configured to run with free run mode enabled. Setting the scan mode to 'free run' causes touch qualification on a new touch to occur as quickly as the scanning engine can convert and process samples on all sensors. In this mode, qualification time is not bounded by active mode scan period, and is only bounded by scanning configuration factors such as the debounce setting, the number of enabled sensors, the accumulation setting on each sensor, and the timing constraints of any enabled component.

For optimal current draw when in active mode, the engine should be configured to use the 'one scan per period' mode setting. In this case, touch qualification is bound by the scan period and the debounce setting of the device.

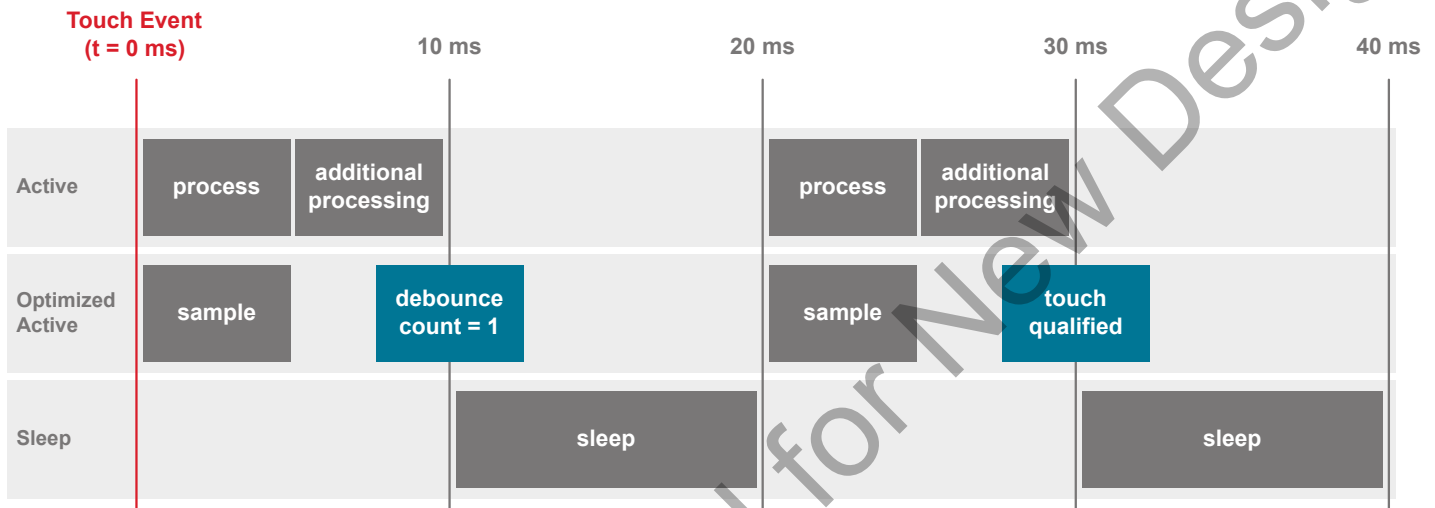

Figure 4.2. Timing and Current — One Sample Per Period Mode

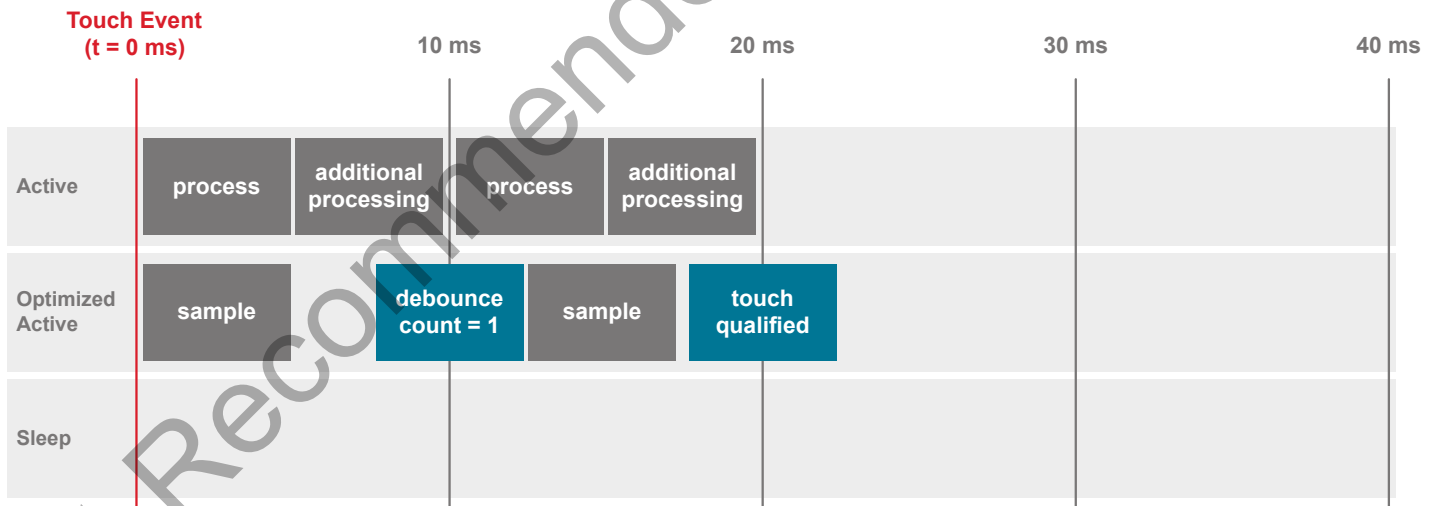

Figure 4.3. Timing and Current — Free Run Mode

4.1.11 Sleep Mode Scan Period

The sleep mode scan period defines the rate at which a scan of the inputs enabled as wake-up sources are sampled. Each enabled sensor can also be enabled as a wake-up source. After the sleep mode scan completes, the scan is processed for a qualified candidate touch. If a candidate touch is qualified, the system wakes from sleep mode and enters active mode scanning.

The sleep mode scan period is stored in the configuration profile and is defined in units of ms.

4.1.12 Active Mode and Sleep Mode Transitions

Capacitive sensing inputs will stay in active mode until no inputs detect qualified touches for a span of time defined by the counts until sleep parameter stored in the configuration profile. The scan period of enabled inputs is defined by the active mode scan period, also found in the configuration profile. If free run mode is enabled, the active mode sensing engine will remain awake and scanning the sensors as fast as possible. If free run mode is disabled, the engine will put itself into a low power state for the remainder of the active mode scan period, after a scan has completed.

When in sleep mode, the sensing engine will wake at a period defined by sleep mode scan period to do a scan on sensors that have been enabled as wakeup sources. If the engine finds a candidate touch in this state, the system reverts to active mode to continue scanning.

Note that in systems where a proximity input is selected, the sleep mode scan engine uses conversions on the proximity input instead of sensors enabled as wakeup sources.

Devices configured to wake on a touch will attempt to qualify the candidate touch that initiated the sleep-to-active transition. If qualification completes successfully, the device will signal this qualification to the external system. Touch qualification of this candidate touch uses the same active mode thresholds, debounce setting, and active mode scan period settings as any touch that occurs during active mode scanning.

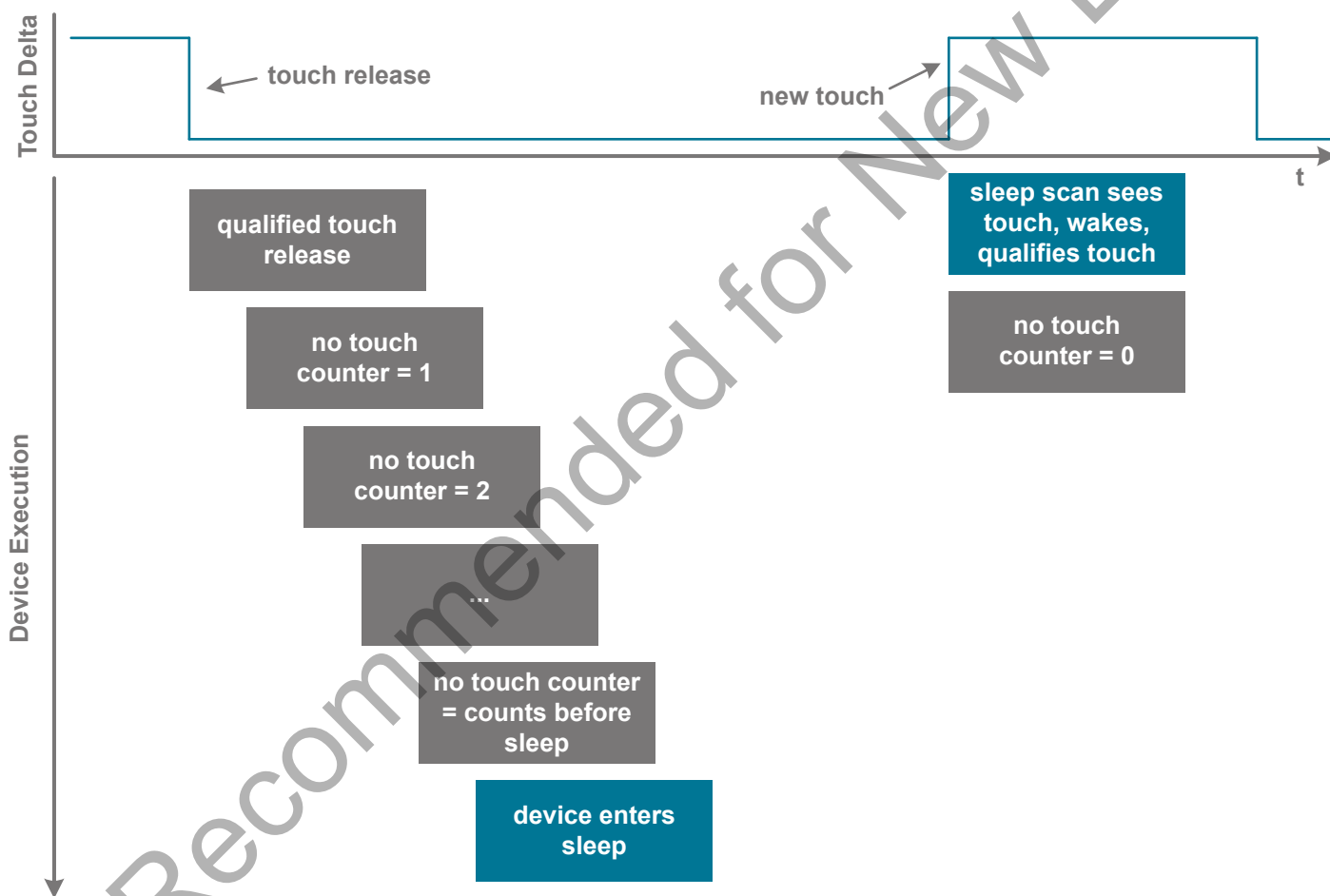

Figure 4.4. Active and Sleep Transitions

4.2 I2C Event Buffer Interface

4.2.1 Introduction

The event buffer I2C interface provides an event-driven, packetized communication system describing newly qualified events generated by the capacitive sensing input engine. The interface runs in one of two mutually exclusive modes: sensing mode and configuration loading mode, where a new configuration profile can be downloaded to the device and stored in non-volatile memory.

In sensing mode, the interface provides access to a first-in-first-out buffer of data packets. When the sensing engine generates these packets and pushes them onto the buffer, the interface then signals the host to indicate that one or more packets are available in the buffer by activating the event buffer interrupt pin.

In sensing mode, the interrupt pin is defined as active-low and operates as a push-pull digital output. In configuration loading mode, the interrupt pin is configured as a digital input and functions as a chip select. I2C transactions will be ignored by the device unless the host has pulled the interrupt pin low before sending the start condition.

The host reads the packets through an I2C interface, with the host acting as an I2C master. Once all packets have been fully transmitted across the I2C interface, the event buffer interrupt pin is de-activated. The device will remain in active mode until no packets remain in the buffer, even if no sensors have been qualified as active for the period of time defined by the active mode scan period.

In configuration loading mode, the interface enables an in-system programming initiated by the host. In this mode, the host can update the performance configuration space.

4.2.2 Startup Behavior

When the device exits a POR or hardware reset, it first enters configuration loading mode, discussed in detail [4.2.10 Configuration Loading Procedure](#). A host can command the device to enter sensing mode using the mode selection command discussed in [4.2.8 Entering Sensing Mode from Configuration Loading Mode](#). If the device has a valid configuration profile stored in non-volatile memory, the device will then enter sensing mode and remain in this mode until the next power cycle or reset.

4.2.3 Sensing Mode Event Packet Structure

Every qualified event detected by the capacitive sensing input engine generates a single packet that can be retrieved by the host processor through the event buffer I2C interface. The packet is an atomic data unit that fully describes the generated event.

Note: The bytes in the packet are transmitted MSB first.

Each packet has a standard structure that can be parsed by the host.

Table 4.1. Standard Packet Structure

Byte #	Designator
0	I2C Slave Address + read bit
1	Packet counter and event type
2	Event description (byte 1)
3	Event description (byte 2)

The packet counter is a 4-bit number stored in the upper bits of byte 1. Each new event will be assigned a counter value that is +1 from the last qualified event. After event 15, the counter wraps back to 0 for the next event. The counter captures the temporal nature of touch events so that a host can reconstruct a sequence of events over time. Also, the host can use the counter value to determine if a packet has been lost due to a buffer overflow. The event buffer counter is reset to 0 upon entrance to sensing mode.

The event type is a 4-bit value describes the originator of the event. For instance, the source could be a capacitive sensing button. The event type is stored in the lower 4 bits of byte 1.

The event description bytes define characteristics of the event that have been qualified. Event descriptions are defined relative to the event source. An event source that is a capacitive sensing input will have a defined set of valid event description values. Those same values will mean something different for a different type of event source. Event description values are defined relative to the event type field of byte 1.

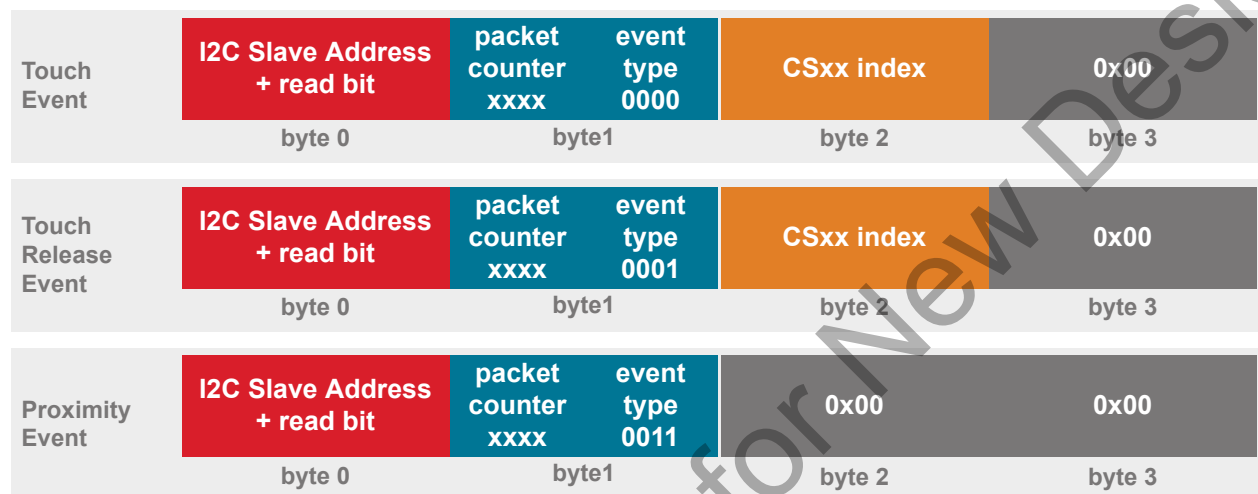

Figure 4.5. I2C Event Buffer Packet Structure

The CSxx index transmitted in byte 2 for Touch and Touch Release events enables the host processor to determine the sensor that caused the event.

4.2.4 Packet Retrieval in Sensing Mode

When the least significant byte of an event packet has been transferred during a master read transaction, that event is popped from the device's buffer. If only a part of the event is read, the event will stay in the buffer and will be transmitted again by the device during the next read.

If the host initiates a master read when the device is in sensing mode but the interrupt pin is not active, signifying that the device has no events in its buffer to transmit, the device will NACK its slave address on the bus.

If the I2C master sends a stop condition on the bus before the entire packet has been read, the device will not pop the packet from its internal buffer. Instead, the I2C state machine will reset, and the next transaction will begin with the first byte of the same event that was being read in the previous, prematurely-terminated transaction.

The I2C event buffer has a depth of 22 events. If the host does not read events promptly after seeing the interrupt pin go active, there is the possibility of a buffer overflow. In the event of an overflow, the I2C engine will discard the oldest events first.

New I2C packets will only be generated at the active mode sample rate, and so the buffer will fill a maximum of 12 packets (in the case simultaneous touch/releases) per sample period. If the host runs the I2C bus at 400 kHz and reads packets as soon as the interrupt pin activates, all packets can be read from the buffer in 1 to 2 ms, which is faster than the rate at which a new active mode scan sequence can complete.

4.2.5 Defined Event Types

The device assigns the following event types:

Table 4.2. Event Type Mapping

Event Type Value	Mapping
Sensing Mode	
0 (0x0)	Sensor activity - touch event
1 (0x1)	Sensor activity - release event
3 (0x3)	Proximity activity
Configuration Loading Mode	
8 (0x8)	Mode selection
9 (0x9)	Configuration unlock
10 (0xA)	Configuration erase
11 (0xB)	Write configuration
12 (0xC)	Write CRC

Note that this event type value is stored in the lower 4 bits of the first non-address byte of a packet. The upper 4 bits are a packet counter value.

4.2.6 Description Bytes for Touch Events

A touch or release event uses only one byte of the description field. That field identifies which sensor caused the touch or release event as shown below.

Table 4.3. Touch or Release Event Sensor Mapping

Value	Mapping
0	Capacitive sensing input 0
1	Capacitive sensing input 1
2	Capacitive sensing input 2
3	Capacitive sensing input 3
4	Capacitive sensing input 4
5	Capacitive sensing input 5
6	Capacitive sensing input 6
7	Capacitive sensing input 7
8	Capacitive sensing input 8
9	Capacitive sensing input 9
10	Capacitive sensing input 10
11	Capacitive sensing input 11

4.2.7 Slave Address

When the device comes out of reset and has not been commanded to enter sensing mode, the device responds to the slave address 0xC0. Additionally, the device will only respond to commands with address 0xC0 if the host drives the interrupt pin low, using the pin as a chip select.

In sensing mode, the device responds to I2C transactions addressed to the slave address stored in the configuration profile.

4.2.8 Entering Sensing Mode from Configuration Loading Mode

Upon exiting reset, the device enters configuration loading mode. During this time, a host can re-write the configuration profile through a sequence of master write commands. The host can also command the device to enter sensing mode using the mode selection command. The mode switch command is structured as shown in the following figure.

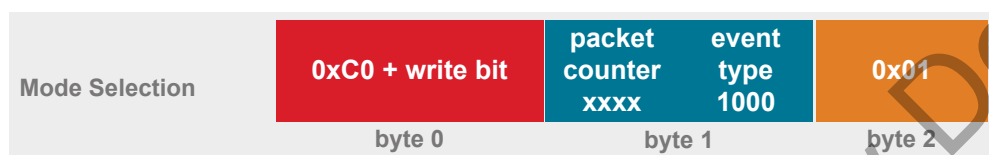

Note: The INT pin must be driven low prior to the I2C start and high after the I2C stop.

Figure 4.6. Mode Selection Command

The device will only enter sensing mode if the configuration profile stored in non-volatile memory is valid. The validity of the configuration profile can be checked using the Configuration Profile Validity Check command.

Note that this mode setting feature must be executed once per device, per reset. Until this command has been received by a device, the device will remain in its startup state and not performing any touch qualification.

4.2.9 Determining Configuration Validity

At any point when the device is in configuration loading mode, the host can issue a Configuration Profile Validity Check command. This command is issued when the host starts a master read command. This command is unique in that it does not include a byte containing the packet counter or event type.

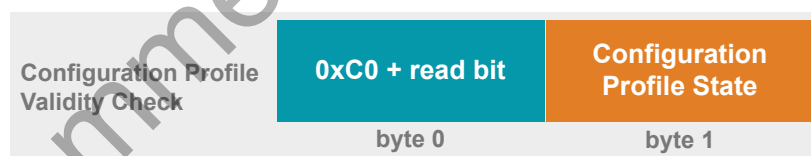

Note: The INT pin must be driven low prior to the I2C start and high after the I2C stop.

Note: This is a read transaction where data is provided from the CPT device.

Figure 4.7. Configuration Profile Validity Check Command

Table 4.4. Decoding the Configuration Profile State

Value	Description
0x80	Configuration profile valid
0x01	Configuration profile invalid

The validity of the configuration profile is determined by comparing a CRC stored in non-volatile memory to a CRC generated at runtime by the device. The CRC is calculated using the algorithm described in [4.2.11 CRC Algorithm](#).

Note: The CRC for the configuration profile spans 510 bytes, with 0xFF padding in addresses above any non-0xFF configuration profile bytes.

Not Recommended for New Designs

4.2.10 Configuration Loading Procedure

Once the device has been configured to configuration bootloader mode, the I2C interface can accept and process the bootloader command set. The bootloading procedure executes as follows in the steps below. Valid bootloader mode commands are shown below.

1. Host sends the configuration loading unlock sequence.
2. Host sends config erase command, which erases the configuration profile. Packet should be resent until device ACKs reception.
3. Host sends bytes 0-7 of configuration profile in a write config command. Packet resent until device ACKs reception.
4. Host repeats process of the previous step, sending the next 8 bytes of the config profile in a write config command, resending until packet is ACKed.
5. After all 8-byte packets of the configuration profile have been transmitted to the device and ACKed by the device, host sends write CRC command. This CRC uses the algorithm described in 4.2.11 CRC Algorithm.
6. Host sends a mode switch command to enter sensing mode.

Once the device has successfully entered sensing mode after a mode switch command, the device will remain in sensing mode until a hardware reset.

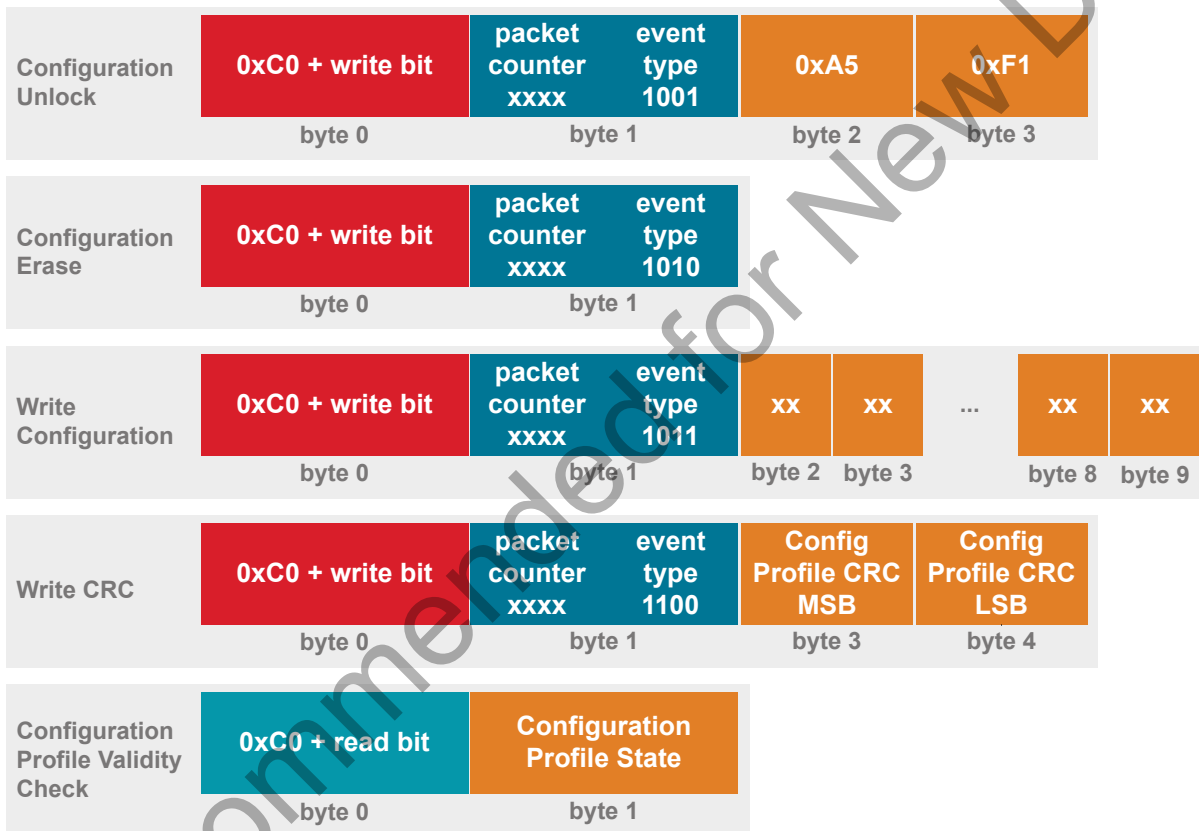

Note: The INT pin must be driven low prior to the I2C start and high after the I2C stop for each of these commands.

Figure 4.8. Configuration Loading Command Sequence

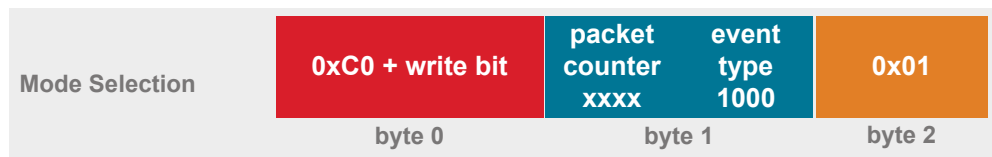

Note: The INT pin must be driven low prior to the I2C start and high after the I2C stop.

Figure 4.9. Entering Sensing Mode

See 4.2.5 [Defined Event Types](#) for a list of all sensing and configuration mode event types values.

Not Recommended for New Designs

4.2.11 CRC Algorithm

The CRC is generated using the standard CCITT-16 16-bit polynomial (0x1021) with an initial seed of 0xFFFF.

The device generates a 16-bit CRC result equivalent to the following algorithm:

1. XOR the input with the most-significant bits of the current CRC result. If this is the first iteration of the CRC unit, the current CRC result will be the set initial value (0x0000 or 0xFFFF).
2. If the MSB of the CRC result is set, shift the CRC result and XOR the result with the polynomial.
3. If the MSB of the CRC result is not set, shift the CRC result.
4. Repeat steps 2 and 3 for all 8 bits.

The algorithm is also described in the following example.

```

unsigned short UpdateCRC (unsigned short CRC_acc, unsigned char CRC_input)
{
    unsigned char i; // loop counter
    #define POLY 0x1021

    // Create the CRC "dividend" for polynomial arithmetic (binary arithmetic
    // with no carries)
    CRC_acc = CRC_acc ^ (CRC_input << 8);

    // "Divide" the poly into the dividend using CRC XOR subtraction
    // CRC_acc holds the "remainder" of each divide
    //
    // Only complete this division for 8 bits since input is 1 byte
    for (i = 0; i < 8; i++)
    {
        // Check if the MSB is set (if MSB is 1, then the POLY can "divide"
        // into the "dividend")
        if ((CRC_acc & 0x8000) == 0x8000)
        {
            // if so, shift the CRC value, and XOR "subtract" the poly
            CRC_acc = CRC_acc << 1;
            CRC_acc ^= POLY;
        }
        else
        {
            // if not, just shift the CRC value
            CRC_acc = CRC_acc << 1;
        }
    }

    // Return the final remainder (CRC value)
    return CRC_acc;
}

```

The following table lists several input values and the associated outputs using this 16-bit CRC algorithm:

Table 4.5. Example 16-bit CRC Outputs

Input	Output
0x63	0xBD35
0x8C	0xB1F4
0x7D	0x4ECA
0xAA, 0xBB, 0xCC	0x6CF6
0x00, 0x00, 0xAA, 0xBB, 0xCC	0xB166

4.3 Capacitive Proximity Sensing

4.3.1 Wake on Proximity

The wake on capacitive proximity detection engine monitors for the presence of a conductive object such as a hand to move within detectable range of the sensor. When the engine detects an object, the device wakes from sleep and can begin qualifying touch events on all sensors enabled for active mode sensing.

4.3.2 Proximity Configuration

The proximity sensing feature uses a single sensor input for proximity qualification. The configuration profile stores the pin chosen by the user. The sensor used for proximity qualification should also have a drive strength setting that is as high as possible without saturating the input when no conductive object is in proximity to the proximity sensor. The accumulation setting of the input is also configurable.

The proximity threshold controls the sensitivity of the input. A lower threshold setting increases sensitivity and increases the range of the sensor.

A proximity sensing input cannot be used for touch qualification, and so the active and inactive thresholds are not used for proximity sensors. Additionally, the proximity input has no effect on other components of the device such as mutually exclusive button groups, buzzer output, and touch time out timers.

4.4 Buzzer Output

4.4.1 Introduction

The buzzer output engine produces a square wave of a configurable duration and frequency when a capacitive sensing input goes from inactive to active. The feature can be enabled and disabled through the configuration profile. The configuration profile also includes the settings for active duration and frequency.

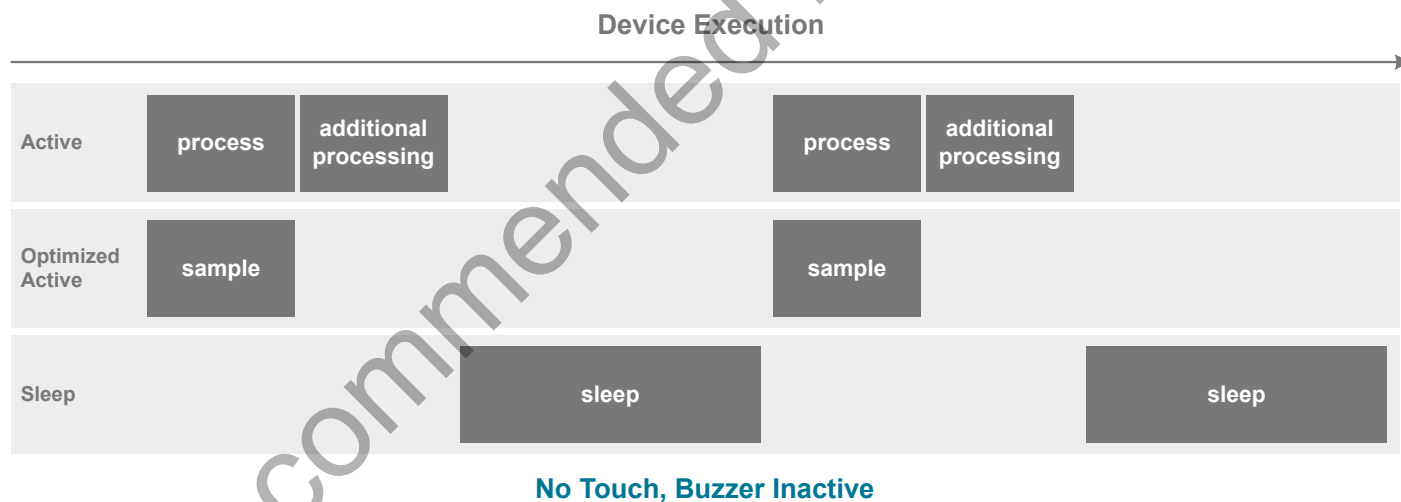
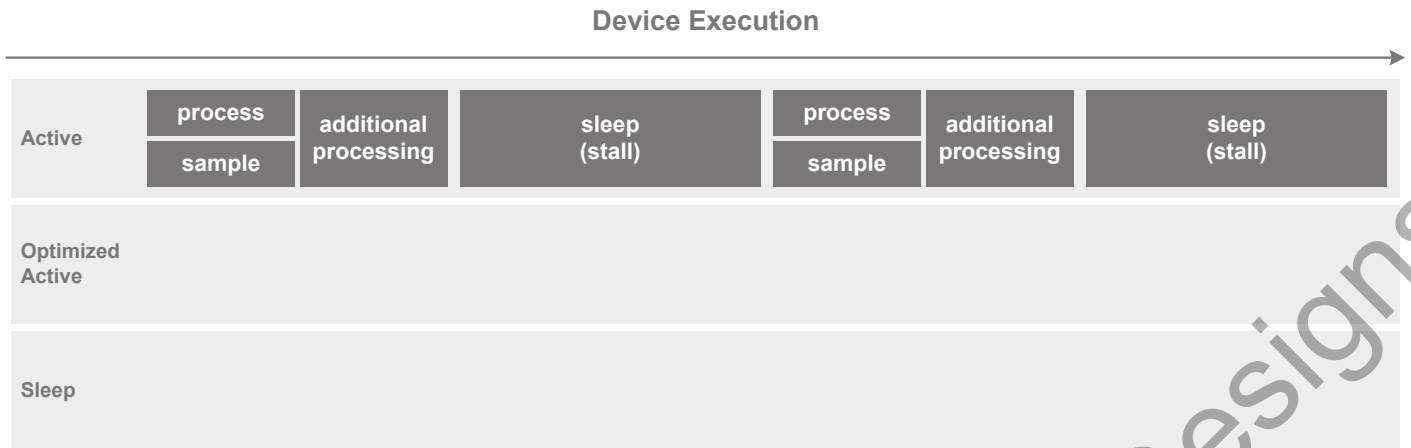

Figure 4.10. Effects of the Buzzer on Current Draw — Active Mode, No Touch, Buzzer Inactive



Touch Detected, Buzzer Active

Figure 4.11. Effects of the Buzzer on Current Draw — Active Mode, Touch Detected, Buzzer Active

4.4.2 Buzzer Configuration

When enabled, buzzer output will appear on the CS11/buzzer pin (pin 10) of the device. When buzzer output is enabled, CS11 is not available for capacitive input sensing.

When activated, the buzzer will remain active for either the duration specified in the configuration profile, or until the last active sensor has qualified a touch release.

The configuration profile supports configuration of output frequencies ranging from 1 kHz to 4 kHz.

The configuration profile can configure the buzzer output pin to either push pull mode or open drain mode.

4.5 Mutually Exclusive Buttons

When enabled through the configuration profile, this system allows one and only one capacitive sensing input to be qualified as active at a time. The first sensor active will remain the only sensor active until released. The device will internally qualify multiple touch and release events but will not report them.

If multiple sensors have been internally qualified as active, the first sensor's touch event will be reported. If a touch event occurs simultaneously on more than one sensor, the touch with the highest touch delta will be reported.

If two sensors are qualified as active and the sensor being reported as active qualifies a touch release, the device will report that release and then report a touch qualification on the still-active second sensor.

In the case where a device has simultaneously qualified more than two active sensors and the reported active sensor qualifies and reports a release, the remaining qualified sensor with the highest sensor name will then be reported. For example, if sensors CS00, CS01, and CS02 are active with CS00 externally reported as active, after CS00's release, CS02 would be externally reported as an active sensor unless the device has already qualified a touch release on CS02.

If both the touch timeout feature and the mutually exclusive button group feature are enabled, the timeout timer will only run on the touch that is externally reported as being active.

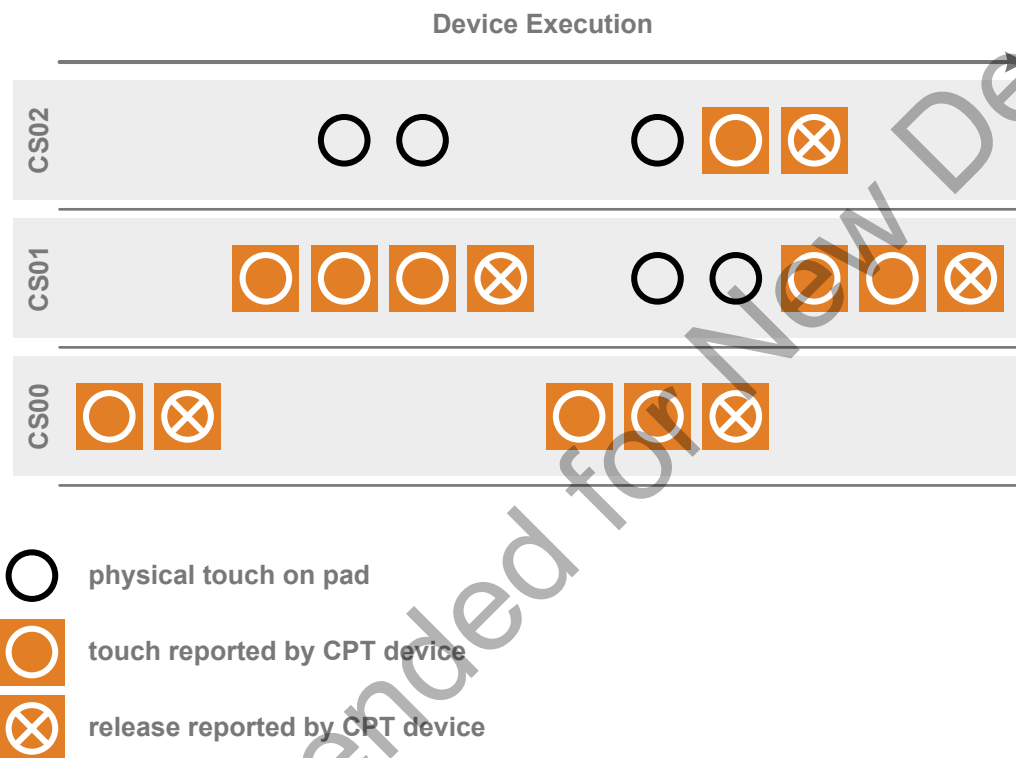

Figure 4.12. Mutually-Exclusive Button Operation

4.6 Configuration Profile

The configuration interface is used by the device to configure default values and performance characteristics that effect capacitive sensing. The configuration data can be programmed through the Configuration interface (Config Clk and Config Data pins) using [Xpress Configurator] in Simplicity Studio or through the I2C interface from the host processor.

Several configuration profile templates are available in Simplicity Studio to provide a starting point for development.

5. Pin Definitions

5.1 CPT212B QFN20 Pin Definitions

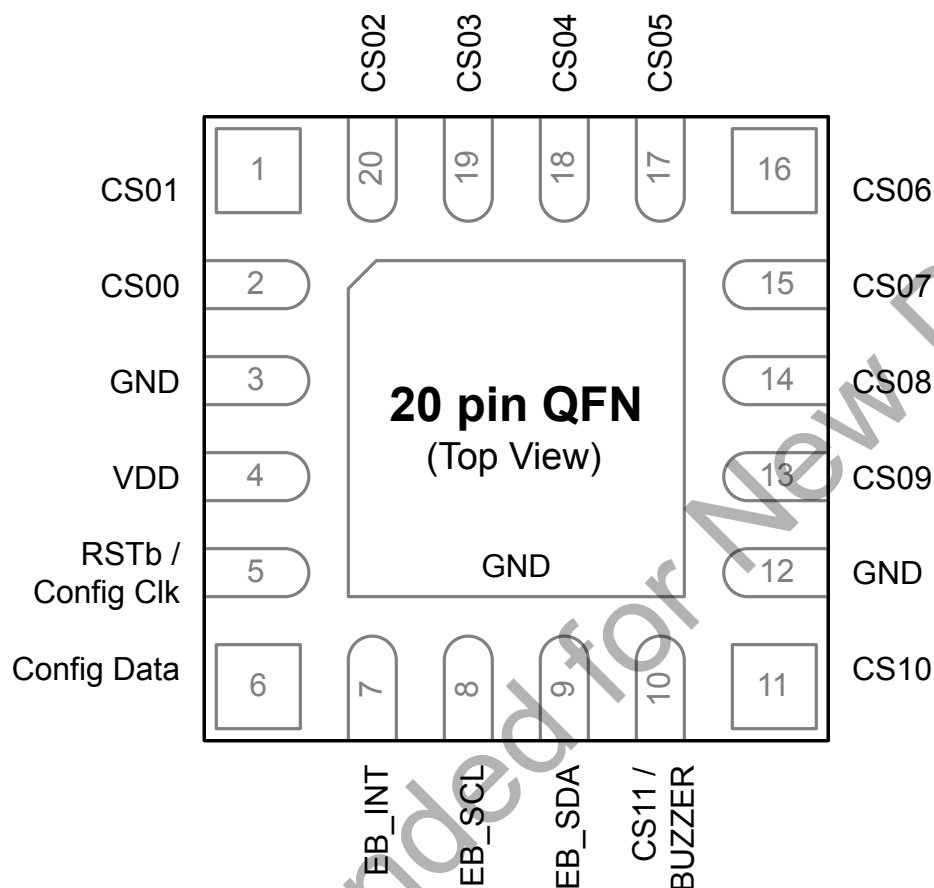

Figure 5.1. CPT212B QFN20 Pinout

Table 5.1. Pin Definitions for CPT212B QFN20

Pin Number	Pin Name	Description
1	CS01	Analog input Capacitive sensing input 1
2	CS00	Analog input Capacitive sensing input 0
3	GND	Ground
4	VDD	Supply power input
5	RSTb / Config Clk	Active-low reset / Configuration clock
6	Config Data	Configuration data

Pin Number	Pin Name	Description
7	EB_INT	Push-pull digital output Event buffer interrupt pin
8	EB_SCL	Open drain digital output Event buffer I2C SCL
9	EB_SDA	Open drain digital input Event buffer I2C SDA
10	CS11 / Buzzer	Analog input, capacitive sensing input 11 Digital output for buzzer
11	CS10	Analog input Capacitive sensing input 10
12	GND	Ground
13	CS09	Analog input Capacitive sensing input 9
14	CS08	Analog input Capacitive sensing input 9
15	CS07	Analog input Capacitive sensing input 7
16	CS06	Analog input Capacitive sensing input 6
17	CS05	Analog input Capacitive sensing input 5
18	CS04	Analog input Capacitive sensing input 4
19	CS03	Analog input Capacitive sensing input 3
20	CS02	Analog input Capacitive sensing input 2

6. QFN20 Package Specifications

6.1 QFN20 Package Dimensions

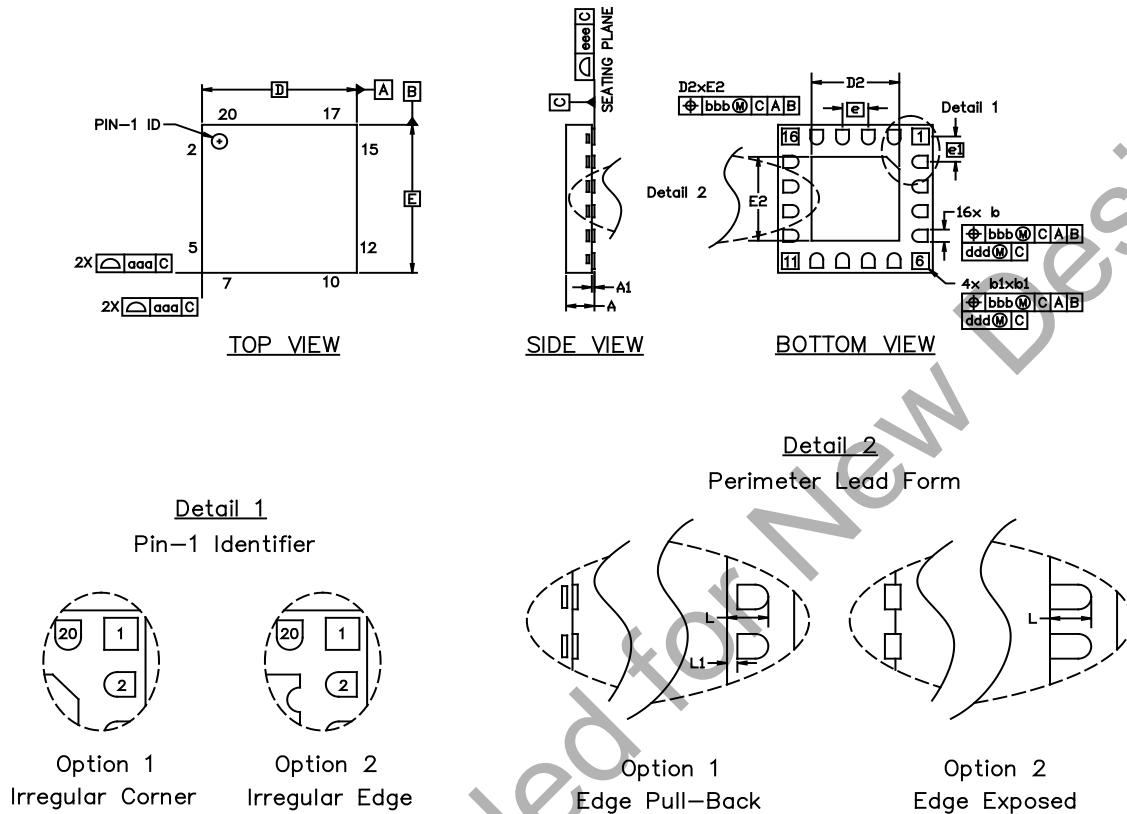

Figure 6.1. QFN20 Package Drawing

Table 6.1. QFN20 Package Dimensions

Dimension	Min	Typ	Max
A	0.50	0.55	0.60
A1	0.00	—	0.05
b	0.20	0.25	0.30
b1	0.275	0.325	0.375
D		3.00 BSC	
D2	1.6	1.70	1.80
e		0.50 BSC	
e1		0.513 BSC	
E		3.00 BSC	
E2	1.60	1.70	1.80
L	0.35	0.40	0.45
L1	0.00	—	0.10

Dimension	Min	Typ	Max
aaa	—	0.10	—
bbb	—	0.10	—
ddd	—	0.05	—
eee	—	—	0.08

Note:

1. All dimensions shown are in millimeters (mm) unless otherwise noted.
2. Dimensioning and Tolerancing per ANSI Y14.5M-1994.
3. This drawing is based upon JEDEC Solid State Product Outline MO-248 but includes custom features which are toleranced per supplier designation.
4. Recommended card reflow profile is per the JEDEC/IPC J-STD-020 specification for Small Body Components.

Not Recommended for New Designs

6.2 QFN20 PCB Land Pattern

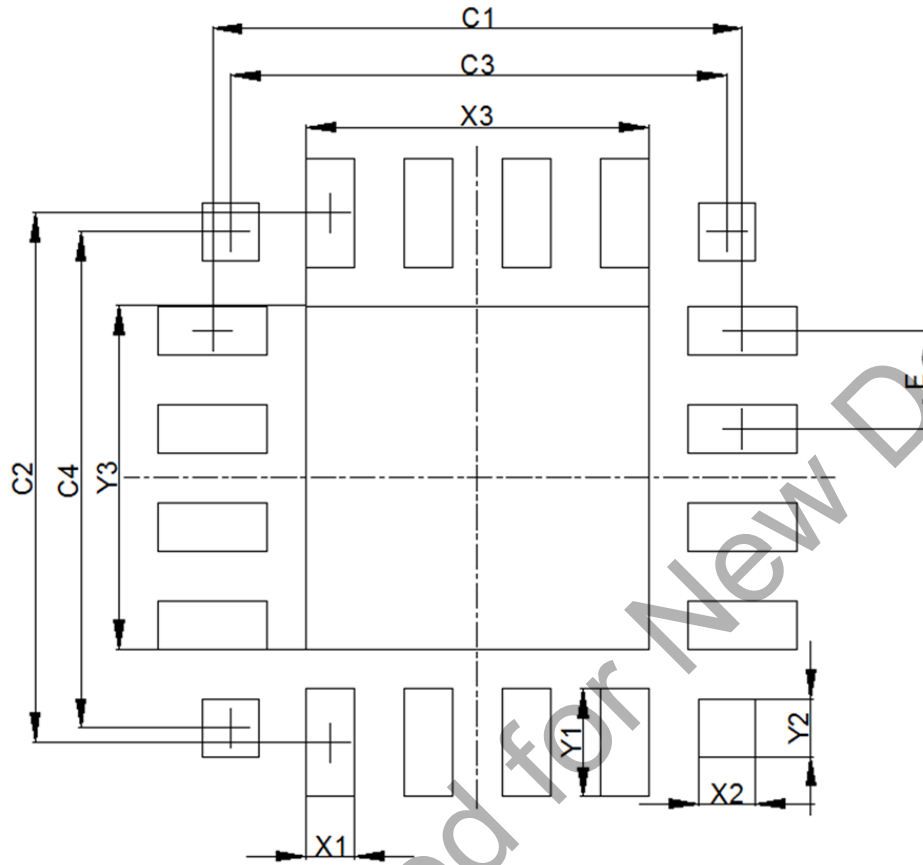

Figure 6.2. QFN20 PCB Land Pattern Drawing

Table 6.2. QFN20 PCB Land Pattern Dimensions

Dimension	Min	Max
C1		2.70
C2		2.70
C3		2.53
C4		2.53
E		0.50 REF
X1	0.20	0.30
X2	0.24	0.34
X3	1.70	1.80
Y1	0.50	0.60
Y2	0.24	0.34
Y3	1.70	1.80

Dimension	Min	Max
Note:		
1. All dimensions shown are in millimeters (mm) unless otherwise noted.		
2. Dimensioning and Tolerancing is per the ANSI Y14.5M-1994 specification.		
3. This Land Pattern Design is based on the IPC-7351 guidelines.		
4. All metal pads are to be non-solder mask defined (NSMD). Clearance between the solder mask and the metal pad is to be 60 µm minimum, all the way around the pad.		
5. A stainless steel, laser-cut and electro-polished stencil with trapezoidal walls should be used to assure good solder paste release.		
6. The stencil thickness should be 0.125 mm (5 mils).		
7. The ratio of stencil aperture to land pad size should be 1:1 for the perimeter pads.		
8. A 2x2 array of 0.75 mm openings on a 0.95 mm pitch should be used for the center pad to assure proper paste volume.		
9. A No-Clean, Type-3 solder paste is recommended.		
10. The recommended card reflow profile is per the JEDEC/IPC J-STD-020 specification for Small Body Components.		

6.3 QFN20 Package Marking

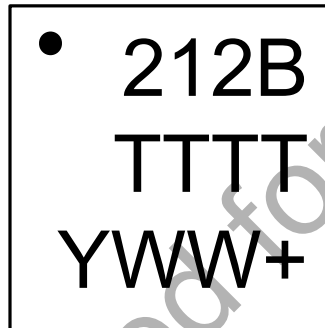

Figure 6.3. QFN20 Package Marking

The package marking consists of:

- 212B – The part number designation.
- TTTT – A trace or manufacturing code. The first letter of this code is the hardware revision.
- Y – The last digit of the assembly year.
- WW – The 2-digit workweek when the device was assembled.
- + – Indicates the device is RoHS-compliant.

7. Relevant Application Notes

The following Application Notes are applicable to the CPT212B devices:

- *AN957: TouchXpress™ Configuration and Profiling Guide* — This application note guides developers through the evaluation and configuration process of TouchXpress devices using Simplicity Studio [**Xpress Configurator**] and [**Capacitive Sense Profiler**].
- *AN447: Printed Circuit Design Notes for Capacitive Sensing Performance* — This document describes hardware design guidelines specifically for capacitive sensing applications, including button placement and other layout guidelines.
- *AN949: TouchXpress™ Programming Guide* — This application note discusses the production programming options available for TouchXpress devices.

Application Notes can be accessed on the Silicon Labs website (www.silabs.com/interface-appnotes) or in Simplicity Studio in the [**Documentation**] > [**Application Notes**] area.

Not Recommended for New Designs

8. Revision History

8.1 Revision 1.1

June 30th, 2017

Added [3.1.5 I2C Configuration Interface](#).

8.2 Revision 1.0

May 10th, 2017

Initial release.

Not Recommended for New Designs

Silicon Labs

Simplicity Studio™4



Simplicity Studio

One-click access to MCU and wireless tools, documentation, software, source code libraries & more. Available for Windows, Mac and Linux!



IoT Portfolio
www.silabs.com/iot



SW/HW
www.silabs.com/simplicity



Quality
www.silabs.com/quality



Support and Community
community.silabs.com

Disclaimer

Silicon Labs intends to provide customers with the latest, accurate, and in-depth documentation of all peripherals and modules available for system and software implementers using or intending to use the Silicon Labs products. Characterization data, available modules and peripherals, memory sizes and memory addresses refer to each specific device, and "Typical" parameters provided can and do vary in different applications. Application examples described herein are for illustrative purposes only. Silicon Labs reserves the right to make changes without further notice and limitation to product information, specifications, and descriptions herein, and does not give warranties as to the accuracy or completeness of the included information. Silicon Labs shall have no liability for the consequences of use of the information supplied herein. This document does not imply or express copyright licenses granted hereunder to design or fabricate any integrated circuits. The products are not designed or authorized to be used within any Life Support System without the specific written consent of Silicon Labs. A "Life Support System" is any product or system intended to support or sustain life and/or health, which, if it fails, can be reasonably expected to result in significant personal injury or death. Silicon Labs products are not designed or authorized for military applications. Silicon Labs products shall under no circumstances be used in weapons of mass destruction including (but not limited to) nuclear, biological or chemical weapons, or missiles capable of delivering such weapons.

Trademark Information

Silicon Laboratories Inc.®, Silicon Laboratories®, Silicon Labs®, SiLabs® and the Silicon Labs logo®, Bluegiga®, Bluegiga Logo®, Clockbuilder®, CMEMS®, DSPLL®, EFM®, EFM32®, EFR®, Ember®, Energy Micro, Energy Micro logo and combinations thereof, "the world's most energy friendly microcontrollers", Ember®, EZLink®, EZRadio®, EZRadioPRO®, Gecko®, ISOModem®, Micrium, Precision32®, ProSLIC®, Simplicity Studio®, SiPHY®, Telegesis, the Telegesis Logo®, USBXpress®, Zentri and others are trademarks or registered trademarks of Silicon Labs. ARM, CORTEX, Cortex-M3 and THUMB are trademarks or registered trademarks of ARM Holdings. Keil is a registered trademark of ARM Limited. All other products or brand names mentioned herein are trademarks of their respective holders.



Silicon Laboratories Inc.
400 West Cesar Chavez
Austin, TX 78701
USA

<http://www.silabs.com>