

UG288: Si72xx-WD-Kit User's Guide

The Si72xx-WD-Kit allows for the evaluation of the Si72xx Hall Sensors through eight demos on the EFM32 Happy Gecko STK. Each of the six base part types are included in the kit on small, postage-stamp-sized (PS) boards with an evaluation demo for each. This user guide describes a quick-start procedure to start the evaluation easily as well as a full description of each demo and a list of compatible PS boards.

The Si72xx-WD Rev 2 Kit includes the following:

- (1) Si72XX-EXP Rev2 Board
- (1) Si7201-B01V-EB Switch PS Board
- (1) Si7202-B01V-EB Latch PS Board
- (1) Si7210-B00V-EB I2C PS Board
- (1) Si7211-B00V-EB Analog PS Board
- (1) Si7212-B00V-EB PWM PS Board
- (1) Si7213-B00V-EB SENT PS Board
- (1) 6-pin, 8-inch ribbon cable
- (2) Loose magnets for PS demos
- (1) CR2032 Coin Cell battery
- (1) Micro USB cable

KEY POINTS

- 8 demos
- Wheel demo showing wheel angular position
- Wheel demo showing revolution counting
- Si7210 postage-stamp-sized board demos including magnetic field data on two scales and temperature
- Switch, analog, PWM, and SENT postage-stamp-sized board demos including tamper indication with an Si7210

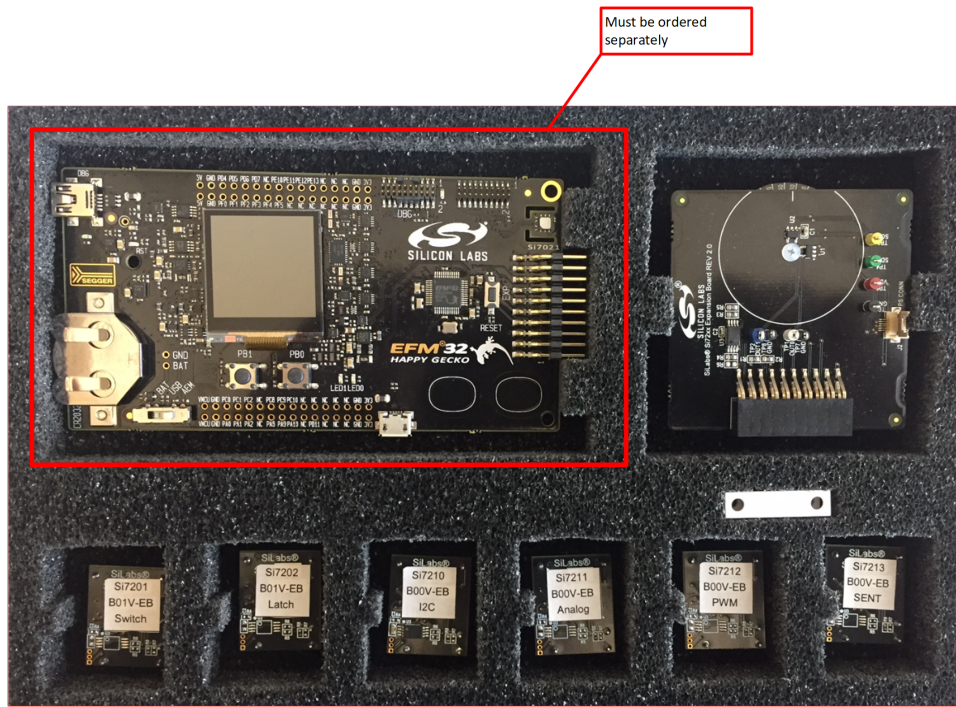

1. Demos

1.1 Demo 1—Wheel Angular Position (Si72xx-EXP)

Section 9 of "AN1018: Using the Si72xx Hall-Effect Magnetic Position Sensors" covers how the hall sensor can be used for a positional measurement by moving the magnetic field. Furthermore, it explains how an MCU can perform an angular position measurement by arranging two hall sensors to sense magnetic field variations from two magnets arranged about the shaft underneath.

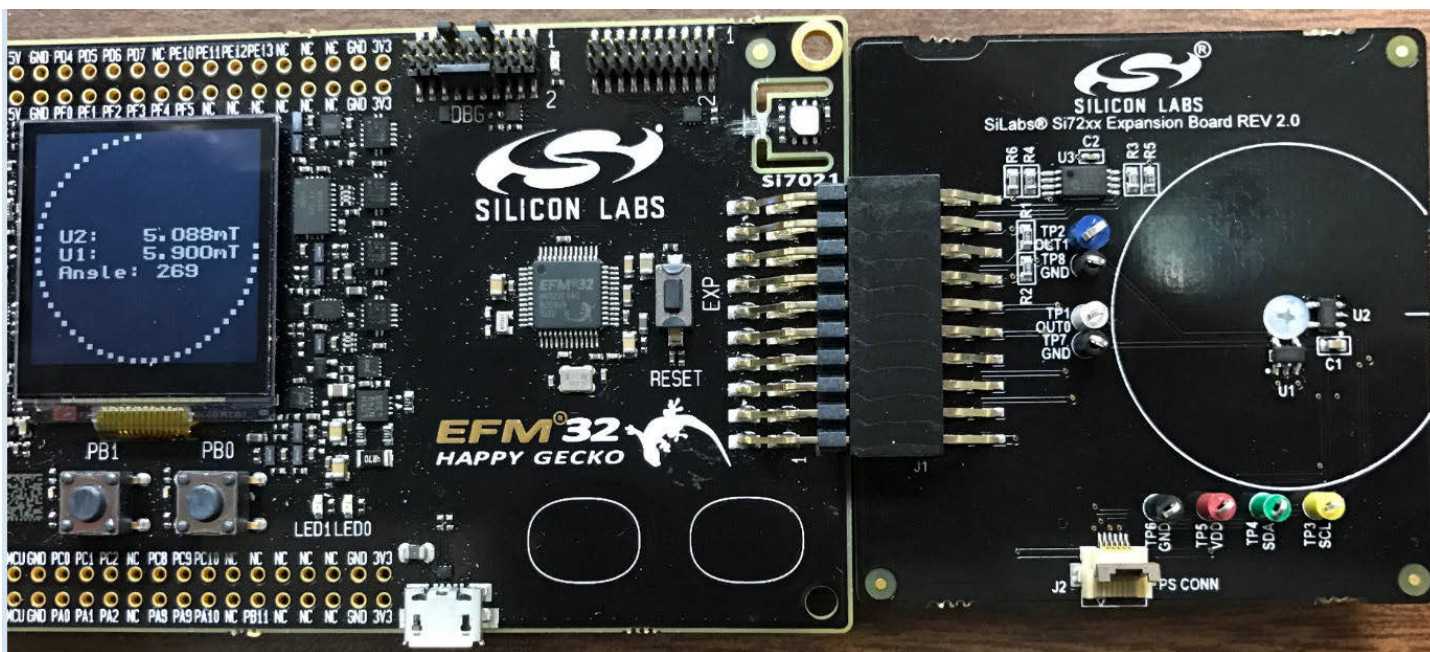

Figure 1.1. Wheel Angular Position Demo

The Wheel Angle Calculation demo determines the angular position of the wheel using two magnetic sensors mounted 90° apart on top of the EXP. Underneath the sensors, a wheel board is connected by a nylon screw which houses two magnets positioned at 45° and 225°. The figures below show the magnets orientated 180° apart, in opposite polarity on the wheel board and how the wheel aligns with the EXP positioning. Using the wheel board as an angle reference, the sensors are positioned so that when U2 is at 0°, U1 is positioned at 270°.

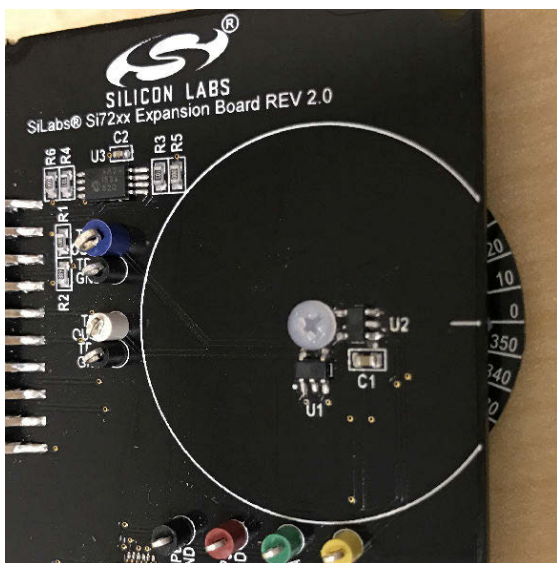

Figure 1.2. Si72xx-EXP Wheel Alignment

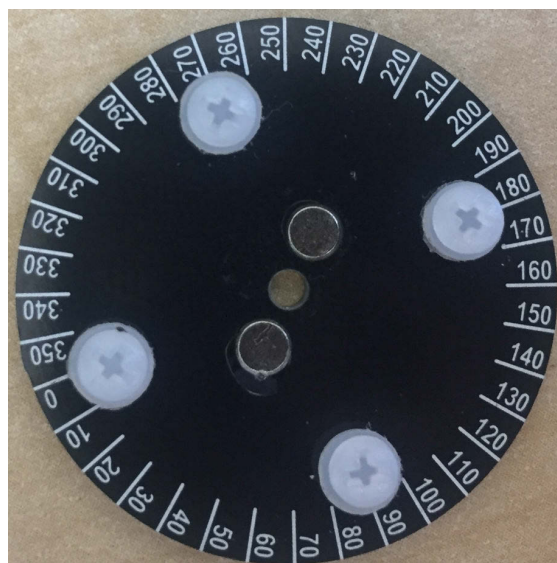

Figure 1.3. Wheel Magnet Orientation

As the angular position varies, the measured magnetic field from each sensor varies as shown below.

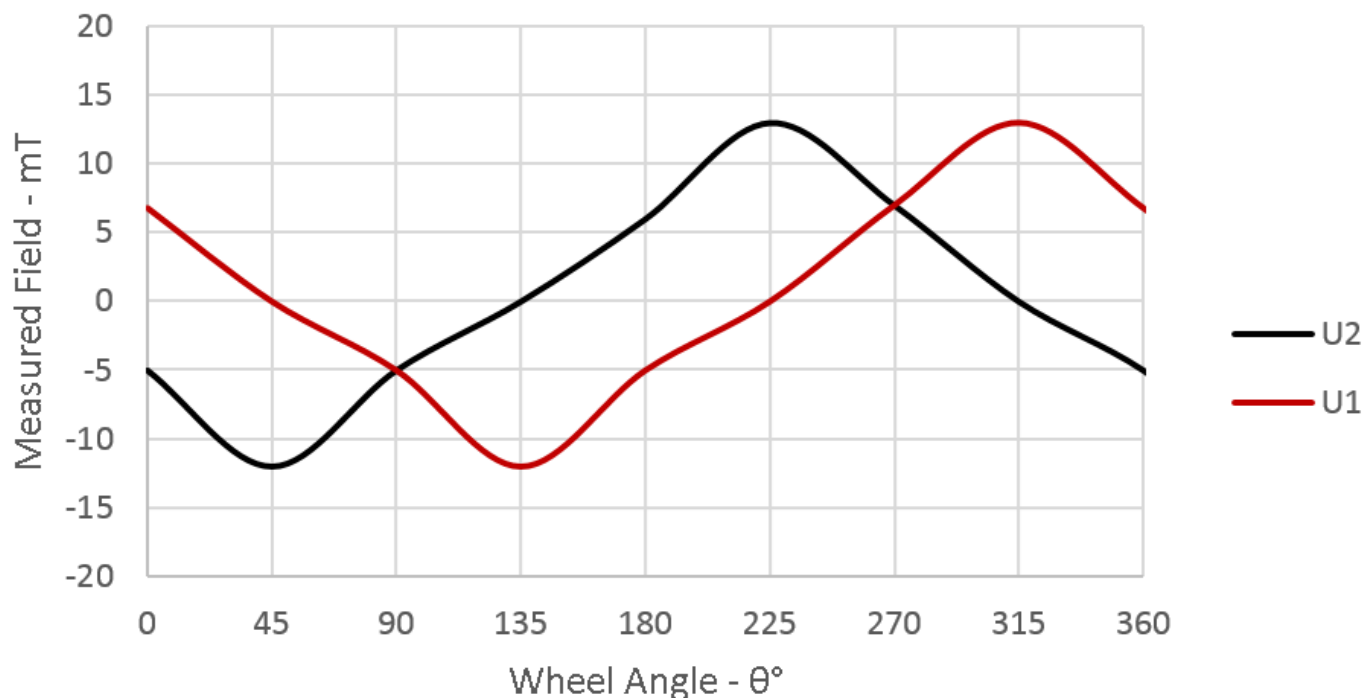

Figure 1.4. Magnetic Field Strength vs. Angle Position

To calculate the angular position, interpolation is applied using the ratio of magnetic field strengths from each sensor against a lookup table. Without calibration, the angle accuracy is within $\pm 5^\circ$ due to variations in the magnets, mechanical alignment and variations in the sensors. The lookup table consists of 36 reference points for each sensor 10° apart. To activate the calibration procedure, follow these steps:

1. Press and hold-down push-button PB1 on the MCU STK.
2. While holding-down PB1, press push-button PB0 on the MCU STK.

Carefully and accurately position the wheel at each angular position to calibrate the lookup table properly. The calibration requires 36 points of calibration that are 10° apart, from 0° to 350° . With calibration, accuracy is better than $\pm 1^\circ$. Due to higher voltage required for flash programming, only perform the calibration with a fresh battery or when USB powered.

1.2 Demo 2—Revolution Counter Using the MCU Pulse Counter (Si72xx-EXP)

Section 10 of "AN1018: Using the Si72xx Hall-Effect Magnetic Position Sensors" explains how the same rotary shaft configuration of the angular position demo can be used for detecting direction and quadrature positioning. Placing the Si7210 sensors on the Si72xx-EXP into a latch mode, the demo counts the total number of wheel revolutions in either direction, with a maximum number of 15 revolutions. To activate the quadrature decoder, press push-button PB1 on the MCU STK. The STK screen will display the quadrature positioning and update the screen once the quadrature position has changed.

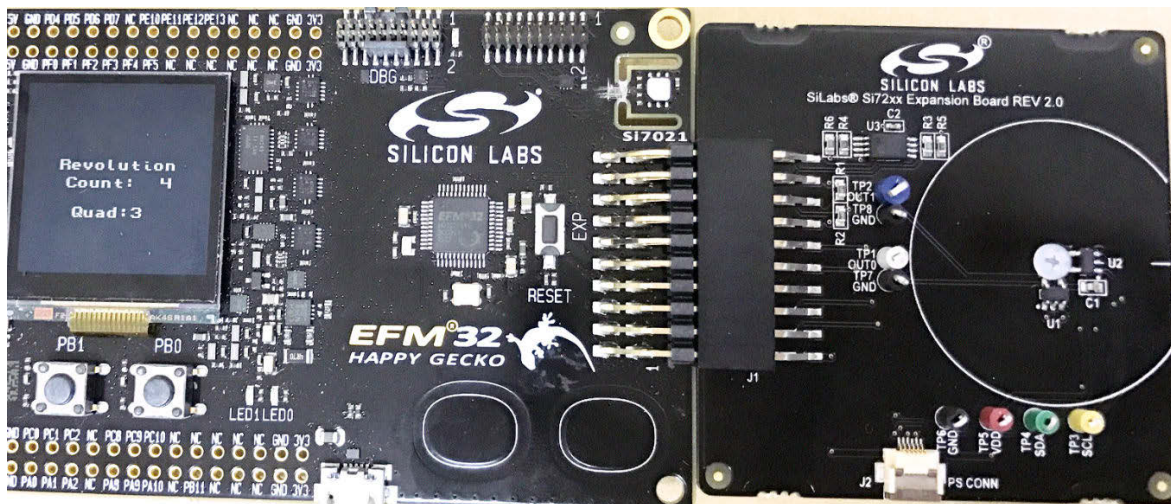

Figure 1.5. Revolution Counter Demo

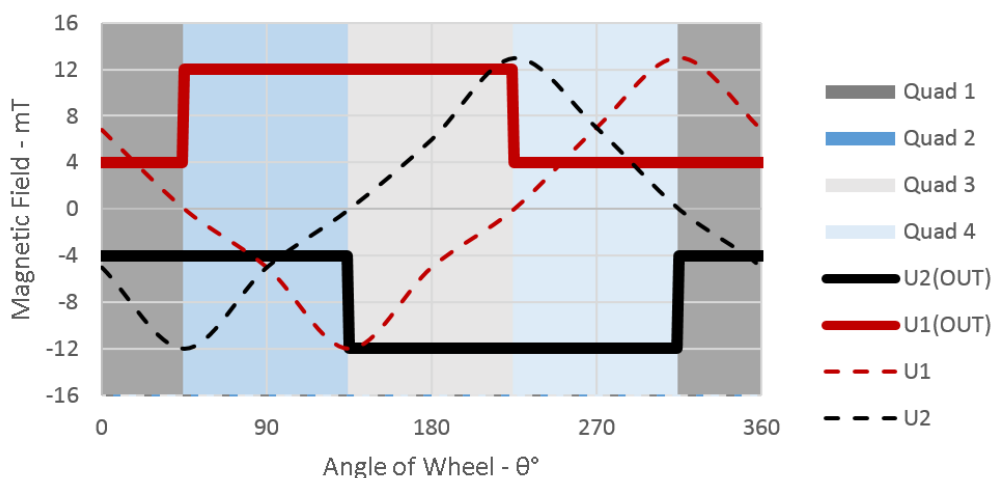

Figure 1.6. Quadrant vs. Wheel Position

Table 1.1. Quadrant Assignments vs. Wheel Position

Quadrant	1	2	3	4
U2 OUT	HIGH	HIGH	LOW	LOW
U1 OUT	LOW	HIGH	HIGH	LOW
U2 Field Polarity	Negative	Negative	Positive	Positive
U1 Field Polarity	Positive	Negative	Negative	Positive
Angle Interval	315° to 45°	45° to 135°	135° to 225°	225° to 315°

1.3 Demo 3—PS Magnetic Field Strength over I²C (SI7210-B00V-EB)

With the Si7210-B00V-EB PS board connected by ribbon cable, the magnetic field readings from the hall sensor on the PS board are displayed on the MCU LCD screen. A magnetic field can be applied to the hall sensor by placing one of the provided loose magnets within near range of the sensor. As detailed in Section 2 of "AN1018: Using the Si72xx Hall-Effect Magnetic Position Sensors", the hall sensor detects the magnetic field going into the bottom of the package. Therefore, it is best to use the magnet positioning shown in the following figures to measure the magnetic field strength for a given distance. The sensor's magnetic field readings are displayed on the STK screen once every second. By default, the sensor uses a ± 20 mT full-scale range for performing magnetic field conversions. This can be converted to a ± 200 mT full-scale range by pressing the push-button PB1 on the STK.

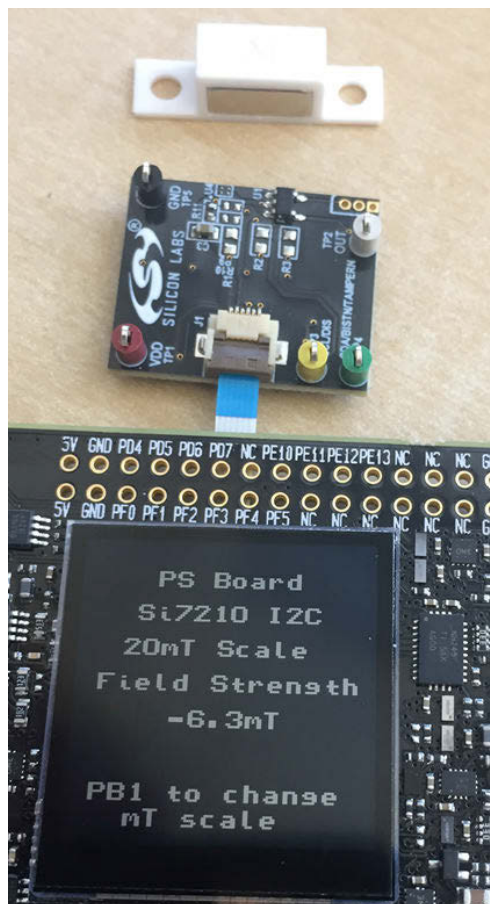

Figure 1.7. 20 mT Data Screen with Negative Field

1.5 Demo 5—PS Switch/Latch (Si7201-B01V-EB, Si7202-B01V-EB or Si7210-B00V-EB)

When the Si7201 “switch” PS board is used the output will be low for the magnet far away. As the magnet is moved closer, the output will go high. When the magnet is moved even closer, the output will go back low indicating a higher than expected magnetic field and demonstrating the “tamper” feature of the Si7201. The Si7201 is “omnipolar”, i.e., it is sensitive to only the magnitude of the magnetic field.

When the Si7202 “latch” PS board is used, the output will go low as the magnet is moved closer and the north side is facing down (positive field). The output will go back high as the magnet is moved closer and the north side is facing up (negative field). The output state is maintained as the magnet is moved away. This is the “latch” feature of the Si7202.

If an Si7210 is detected on the I²C bus, this is displayed on the screen. The Si7210 demo in this case still shows the output pin status as high or low depending on the magnet location. When the output goes low, the microprocessor will read the magnetic field and display “tamper” if the magnetic field is high.

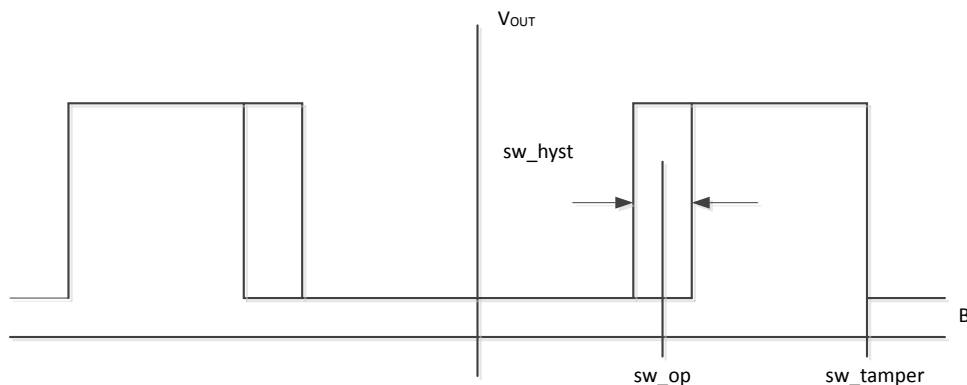
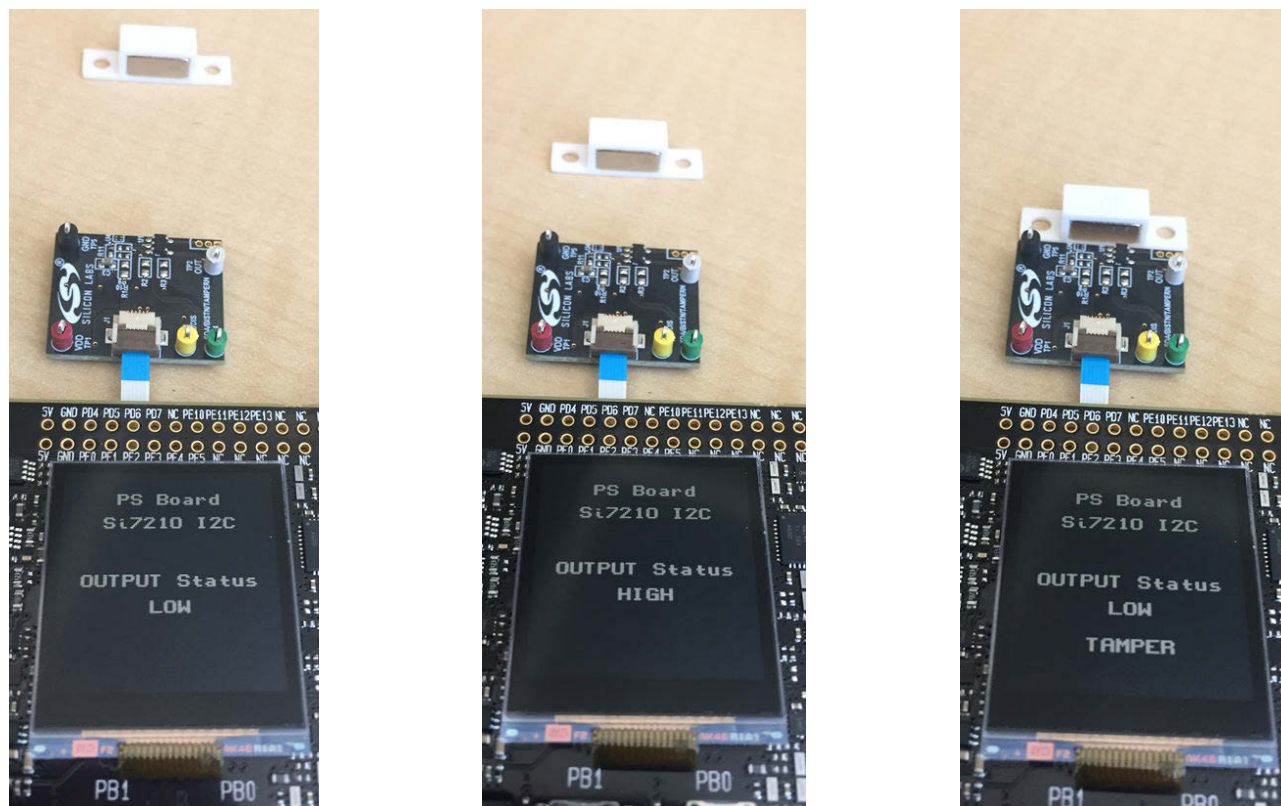

Figure 1.13. Si7210 Switch Demo

1.7 Demo 7—PS PWM Output (Si7212-B00V-EB)

With the Si7212-B00V-EB PS board connected by ribbon cable, the PWM duty cycle from the hall sensor on the PS board is displayed on the MCU LCD screen. The duty cycle percentage reported on the screen is with respect to the high signal. The MCU translates the PWM percentage in a magnetic field strength assuming the sensor is factory programmed for a 20 mT full-scale. Measurements are performed once every second and updated on the LCD screen.

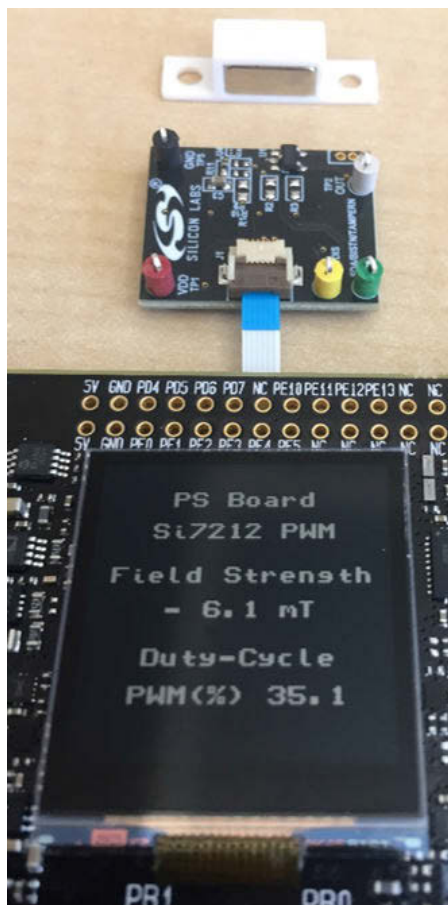

Figure 1.11. PWM Screen

1.8 Demo 8—PS SENT Output (Si7213-B00V-EB)

With the Si7213-B00V-EB PS board connected by ribbon cable, the SENT nibble data for the magnetic field reading from the hall sensor on the PS board is displayed on the MCU LCD screen. The MCU translates the nibble data into a magnetic field strength assuming the sensor is factory programmed for a 20 mT full-scale. Measurements are performed once every second and updated on the LCD screen.

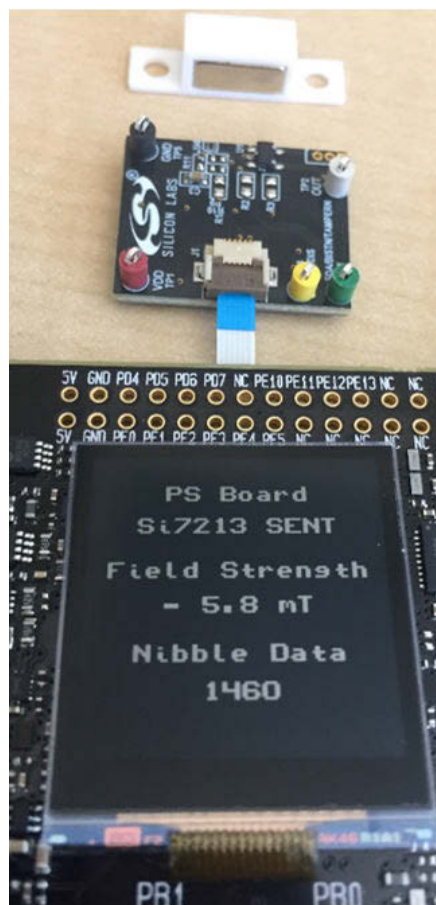

Figure 1.12. Sent Screen

2.2 Postage Stamp Board Schematic

The PS board is laid out out to accommodate several different package types. By default, the SOT23 package is populated, and no pull-up resistors are populated.

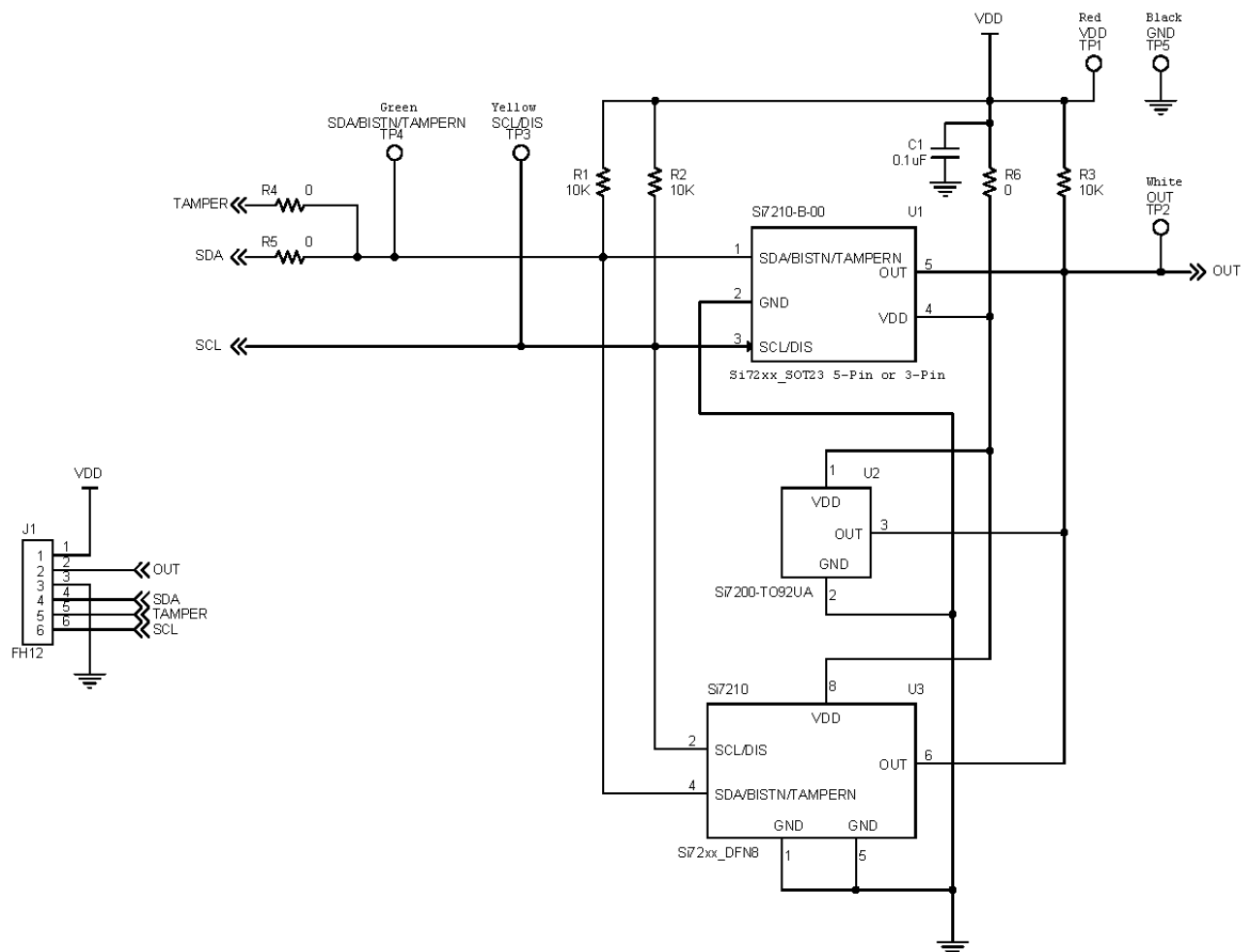
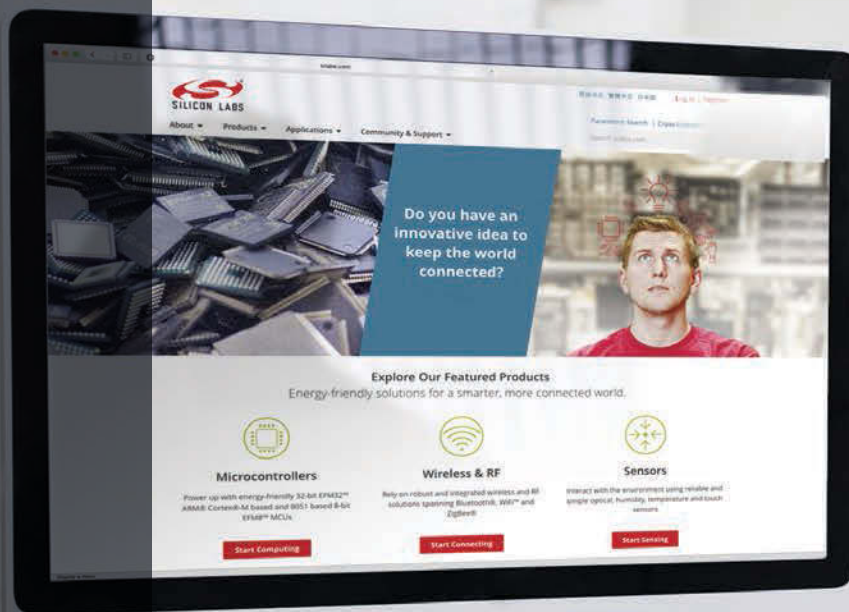

Figure 2.2. Postage Stamp Board Schematic

3. Revision Notes

Revision 0.1. Some early kits were made with Revision "A" sensors. These are functionally equivalent to Revision B except that there can be a powerup issue at low Vdd. The powerup issue is generally not seen because it happens at a voltage lower than the voltage required for the display. If it happens, cycle the power, and the problem should resolve itself.



Smart.
Connected.
Energy-Friendly.



Products
www.silabs.com/products

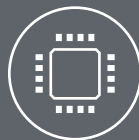

Quality
www.silabs.com/quality



Support and Community
community.silabs.com

Disclaimer

Silicon Labs intends to provide customers with the latest, accurate, and in-depth documentation of all peripherals and modules available for system and software implementers using or intending to use the Silicon Labs products. Characterization data, available modules and peripherals, memory sizes and memory addresses refer to each specific device, and "Typical" parameters provided can and do vary in different applications. Application examples described herein are for illustrative purposes only. Silicon Labs reserves the right to make changes without further notice to the product information, specifications, and descriptions herein, and does not give warranties as to the accuracy or completeness of the included information. Without prior notification, Silicon Labs may update product firmware during the manufacturing process for security or reliability reasons. Such changes will not alter the specifications or the performance of the product. Silicon Labs shall have no liability for the consequences of use of the information supplied in this document. This document does not imply or expressly grant any license to design or fabricate any integrated circuits. The products are not designed or authorized to be used within any FDA Class III devices, applications for which FDA premarket approval is required or Life Support Systems without the specific written consent of Silicon Labs. A "Life Support System" is any product or system intended to support or sustain life and/or health, which, if it fails, can be reasonably expected to result in significant personal injury or death. Silicon Labs products are not designed or authorized for military applications. Silicon Labs products shall under no circumstances be used in weapons of mass destruction including (but not limited to) nuclear, biological or chemical weapons, or missiles capable of delivering such weapons. Silicon Labs disclaims all express and implied warranties and shall not be responsible or liable for any injuries or damages related to use of a Silicon Labs product in such unauthorized applications.

Trademark Information

Silicon Laboratories Inc.®, Silicon Laboratories®, Silicon Labs®, SiLabs® and the Silicon Labs logo®, Bluegiga®, Bluegiga Logo®, ClockBuilder®, CMEMS®, DSPLL®, EFM®, EFM32®, EFR, Ember®, Energy Micro, Energy Micro logo and combinations thereof, "the world's most energy friendly microcontrollers", Ember®, EZLink®, EZRadio®, EZRadioPRO®, Gecko®, Gecko OS, Gecko OS Studio, ISOModem®, Precision32®, ProSLIC®, Simplicity Studio®, SiPHY®, Telegesis, the Telegesis Logo®, USBXpress®, Zentri, the Zentri logo and Zentri DMS, Z-Wave®, and others are trademarks or registered trademarks of Silicon Labs. ARM, CORTEX, Cortex-M3 and THUMB are trademarks or registered trademarks of ARM Holdings. Keil is a registered trademark of ARM Limited. Wi-Fi is a registered trademark of the Wi-Fi Alliance. All other products or brand names mentioned herein are trademarks of their respective holders.



Silicon Laboratories Inc.
400 West Cesar Chavez
Austin, TX 78701
USA

<http://www.silabs.com>